



The Gerber Format Specification

A format developed by Ucamco

Revision 2019.06



Contents

Contents	2
Preface.....	7
1 Introduction	8
1.1 Scope and Target Audience	8
1.2 Further Resources.....	8
1.3 Reference Gerber Viewer	8
1.4 Questions	8
1.5 Copyright and Intellectual Property	10
1.6 About Ucamco.....	10
2 Overview	11
2.1 File Structure	11
2.2 Apertures.....	11
2.3 Graphics Objects.....	12
2.4 Draws and Arcs	12
2.5 Operations (D01, D02, D03).....	14
2.6 Graphics State.....	14
2.7 Polarity	17
2.8 Blocks.....	18
2.9 Attributes	18
2.10 Command Overview.....	19
2.11 Processing a Gerber File.....	20
2.12 Glossary.....	22
2.13 Example Files	25
2.13.1 Example: Two Square Boxes	25
2.13.2 Example: Polarities and Apertures	26
2.13.3 Example: A Drill File.....	30
2.14 Conformance	32
3 Syntax	34
3.1 Conventions for Syntax Rules.....	34
3.2 File Extension, MIME Type and UTI	35
3.3 Character Set	36
3.4 Data Blocks	36
3.5 Commands.....	37
3.5.1 Command Syntax Overview.....	37
3.5.2 Function Code Commands	37

3.5.3 Extended Commands	38
3.6 Data Types	40
3.6.1 Integers.....	40
3.6.2 Decimals.....	40
3.6.3 Coordinate Data.....	40
3.6.4 Hexadecimal	40
3.6.5 Names	40
3.6.6 Strings	41
3.6.7 Fields	41
4 Graphics	42
4.1 Format Specification (FS).....	42
4.2 Unit (MO).....	43
4.3 Aperture Definition (AD).....	44
4.3.1 AD Command	44
4.3.2 Zero-size Apertures	44
4.3.3 Examples.....	45
4.4 Standard Aperture Templates.....	46
4.4.1 Overview.....	46
4.4.2 Circle	46
4.4.3 Rectangle.....	48
4.4.4 Obround.....	49
4.4.5 Polygon.....	50
4.4.6 Transparency of Holes	51
4.5 Aperture Macro (AM)	52
4.5.1 AM Command.....	52
4.5.2 Exposure Modifier	54
4.5.3 Rotation Modifier.....	55
4.5.4 Primitives	56
4.5.5 Syntax Details.....	66
4.5.6 Examples	70
4.6 Block Aperture (AB).....	74
4.6.1 Overview of block apertures.....	74
4.6.2 AB Statement Syntax.....	74
4.6.3 Usage of Block Apertures	75
4.6.4 Example.....	76
4.7 Set Current Aperture (Dnn).....	78
4.8 Operations (D01/D02/D03)	79
4.8.1 Coordinates	80
4.8.2 D01 Command.....	81
4.8.3 D02 Command.....	81
4.8.4 D03 Command.....	81
4.8.5 Example.....	82
4.9 Linear Interpolation Mode (G01).....	83

4.9.1 G01 Command	83
4.9.2 D01 Command.....	83
4.10 Circular Interpolation (G02/G03) and (G74/G75)	84
4.10.1 Circular Arc Overview	84
4.10.2 G02 & G03 Command.....	86
4.10.3 G74 & G75 Command.....	86
4.10.4 D01 Command.....	86
4.10.5 Example: Single Quadrant Mode	89
4.10.6 Example: Multi Quadrant Mode	90
4.10.7 Numerical Instability in Multi Quadrant (G75) Arcs	91
4.10.8 Using G74 or G75 May Result in a Different Image.....	91
4.11 Object Transformations (LP, LM, LR, LS).....	93
4.11.1 Overview.....	93
4.11.2 Load Polarity (LP)	95
4.11.3 Load Mirroring (LM)	95
4.11.4 Load Rotation (LR).....	95
4.11.5 Load Scaling (LS)	96
4.11.6 Examples	96
4.12 Region Statement (G36/G37).....	99
4.12.1 Region Overview.....	99
4.12.2 Region Statement Syntax	100
4.12.3 Valid Contours	101
4.12.4 Examples	102
4.12.5 Power and Ground Planes	119
4.13 Step and Repeat (SR).....	122
4.14 Comment (G04)	125
4.15 End-of-file (M02)	126
4.16 Numerical Accuracy in Image Processing and Visualization.....	127
4.16.1 Visualization.....	127
4.16.2 Image Processing	127
5 Attributes	129
5.1 Attributes Overview	129
5.2 File Attributes (TF).....	131
5.3 Aperture Attributes (TA).....	131
5.3.1 Aperture Attributes on Regions	132
5.4 Object Attributes (TO).....	132
5.5 Delete Attribute (TD).....	132
5.6 Standard Attributes.....	133
5.6.1 Overview.....	133
5.6.2 .Part.....	135
5.6.3 .FileFunction	136
5.6.4 .FilePolarity	140
5.6.5 .SameCoordinates	141

5.6.6 .CreationDate.....	141
5.6.7 .GenerationSoftware	142
5.6.8 .ProjectId	142
5.6.9 .MD5	143
5.6.10 .AperFunction	145
5.6.11 .DrillTolerance.....	153
5.6.12 .FlashText.....	153
5.6.13 .N (Net)	154
5.6.14 .P (Pin).....	156
5.6.15 .C (Component)	158
5.7 Text in the Image.....	159
5.8 PCB Fabrication Data.....	159
5.8.1 Structure	159
5.8.2 Alignment.....	159
5.8.3 Essential Attributes	159
5.8.1 The Profile	160
5.8.2 Drill files	160
5.8.3 Drawings and Data	161
5.8.4 The CAD Netlist	161
5.9 Examples	164
6 Errors and Bad Practices.....	166
6.1 Errors	166
6.2 Bad Practices	169
7 Deprecated Format Elements.....	171
7.1 Deprecated Commands.....	171
7.1.1 Overview.....	171
7.1.2 Axis Select (AS).....	172
7.1.3 Image Name (IN)	173
7.1.4 Image Polarity (IP)	174
7.1.5 Image Rotation (IR).....	174
7.1.6 Load Name (LN)	175
7.1.7 Mirror Image (MI)	176
7.1.8 Offset (OF).....	177
7.1.9 Scale Factor (SF).....	177
7.2 Coordinate Data without Operation Code	179
7.3 Format Specification Options.....	180
7.3.1 Trailing Zero Omission	180
7.3.2 Incremental Notation	180
7.3.3 Low resolution.....	181
7.4 Using G01/G02/G03 in a data block with D01/D02	181
7.5 Deprecated usage of SR	182

7.6 Rectangular Hole in Standard Apertures	182
7.7 Painting or Vector-fill	184
7.8 Deprecated Terminology	184
7.9 Deprecated Attribute Values.....	184
7.10 Standard Gerber (RS-274-D)	185
8 References.....	186
9 History.....	187
10 Revisions	189
10.1 Revision 2019.06	189
10.2 Revision 2018.11	189
10.3 Revision 2018.09	189
10.4 Revision 2018.06	189
10.5 Revision 2018.05	189
10.6 Revision 2017.11	190
10.7 Revision 2017.05	190
10.8 Revision 2017.03	190
10.9 Revision 2016.12	190
10.10Revision 2016.11	191
10.11Revision 2016.09	191
10.12Revision 2016.06	191
10.13Revision 2016.04	192
10.14Revision 2016.01	192
10.15Revision 2015.10	192
10.16Revision 2015.07	192
10.17Revision 2015.06	192
10.18Revision J4 (2015 02)	193
10.19Revision J3 (2014 10)	193
10.20Revision J2 (2014 07)	193
10.21Revision J1 (2014 02)	193
10.22Revision I4 (2013 10)	193
10.23Revision I3 (2013 06)	193
10.24Revision I2 (2013 04)	193
10.25Revision I1 (2012 12)	194

Preface

The Gerber file format is the de facto standard for printed circuit board (PCB) design data transfer. Every PCB design system outputs Gerber files and every PCB fabrication software inputs them. Implementations are thoroughly field-tested and debugged. Gerber's widespread availability allows PCB professionals to exchange PCB design data securely and efficiently. It has been called "the backbone of the electronics fabrication industry".

The Gerber format is an open ASCII vector format for 2D binary images specifying copper layers, solder mask, legend, etc. The Gerber file format is simple, compact and unequivocal. It describes an image with very high precision. It is portable and easy to debug by its use of printable 7-bit ASCII characters.

A set of well-constructed Gerber file precisely defines the PCB image and the function of the objects, reliably and productively transferring PCB fabrication data from design to fabrication.

Attributes transfer the meta-information needed by fabrication. Attributes are akin to labels providing information associated with the image or features in it. Examples of metadata conveyed by attributes are:

- The function of the file. Is the file the top solder mask, or the bottom copper layer, etc.?
- The function of a pad. Is the flash an SMD pad, or a via pad, or a fiducial, etc.

Files containing attributes are called Gerber X2 files, files without attributes Gerber X1.

RS-274X or Extended Gerber, either X1 or X2, is the current Gerber format. RS-274-D of Standard Gerber is obsolete and now revoked. It was superseded by RS-274X decades ago. Do not use Standard Gerber any longer.

Although other data formats have appeared, they have not displaced Gerber. The reason is simple. The problems in PCB fabrication data transfer are not due to limitations in the Gerber format but poor practices and poor implementations. To quote a PCB fabricator: "If we would only receive proper Gerber files, it would be a perfect world." The new formats are more complex and less transparent to the user. Poor practices and errors in unfamiliar, new and more complex formats are more damaging than in a well-known, well-tested and simple format. The industry has not adopted new formats. Gerber remains the standard.

Ucamco continuously clarifies this document based on input from the field and adapts it to current needs. Ucamco thanks the individuals that help us with comments, criticism and suggestions. We urge Gerber software developers to monitor these revisions.

The emergence of Gerber as a standard for PCB fabrication data is the result of efforts by many individuals who developed outstanding software for Gerber files. Without their dedication there would be no standard format in the electronics fabrication industry. Ucamco thanks these dedicated individuals.

Karel Tavernier

Managing Director,
Ucamco

1 Introduction

1.1 Scope and Target Audience

This document specifies the Gerber file format, an ASCII vector image file format representing a 2D bi-level (binary, having two colors) images. It is intended for developers and users of Gerber software.

The Gerber format is the de facto standard in the printed circuit board (PCB) industry but it also used in other industries. A basic knowledge of PCB CAD/CAM is helpful for understanding this specification.

1.2 Further Resources

The Ucamco website contains articles about the use of the Gerber format as well as sample files. For more information about Gerber or Ucamco see www.ucamco.com.

1.3 Reference Gerber Viewer

Ucamco provides a reference X1 and X2 Gerber file viewer - free of charge – at gerber-viewer.ucamco.com.

The Reference Gerber Viewer provides an *easy-to-use reference* for both X1 and X2 Gerber files. - the utmost care was taken to display valid Gerber files correctly. It gives a clear warning on risky errors. It is a convenient complement to the written specification (The specification has precedence if it conflicts with the viewer.)

It is allowed to integrate a link to the online reference viewer in your website to help keep Gerber files on the straight and narrow path of full compliance to the specification.

The Reference Gerber Viewer also provides an easy tool to *review PCB fabrication date*. For convenience, it reverse engineers the intended image on an invalid Gerber file. For completeness, it will also display drill files in NC format as well as netlists in IPC-D-356 files. If X2 is used the layer structure is displayed, and the function of all objects can be checked – e.g. whether a pad is a via pad or not.

As the Reference Gerber Viewer is a cloud-based on-line web service there is no software to download, install and maintain –it is always up to date. It is kept simple and easy to learn. It offers the following benefits:

- *For developers*, it provides an easy way to test their Gerber output and to answer questions about the interpretation of the specification.
- *For recipients of Gerber files*, it provides an easy way to check the image of the file they are about to send.
- *For creators of Gerber files*, it provides an easy way to validate their input and arbitrate in discussions about the valid interpretation of a file.

1.4 Questions

Ucamco strives to make this specification easy to read and unequivocal. If you find a part of this specification unclear, please ask. Your question will be answered, and it will be considered to improve this document. We are grateful for any suggestion for improvement.

The Gerber format includes a set of standard attributes to transfer meta-information in the PCB industry. We are open to your suggestions for other new generally useful attributes.

We can be reached at gerber@ucamco.com.

1.5 Copyright and Intellectual Property

© Copyright Ucamco NV, Gent, Belgium

Ucamco owns copyrights in this document. All rights reserved. No part of this document or its content may be re-distributed, reproduced or published, modified or not, translated or not, in any form or in any way, electronically, mechanically, by print or any other means without prior written permission from Ucamco. One reason Ucamco must retain its copyrights in the Gerber Format® specification is to maintain the integrity of the standard.

The information contained herein is subject to change without prior notice. Revisions may be issued from time to time. This document supersedes all previous versions. Users of the Gerber Format®, especially software developers, must consult www.ucamco.com to determine whether new revisions were issued.

Ucamco developed the Gerber Format®. All intellectual property contained in it is solely owned by Ucamco. By publishing this document Ucamco has not granted any license or alienated any rights to the intellectual property contained in it. To use this intellectual property, developers of software interfaces based on this format specification must make a reasonable effort to comply with the latest revision of the specification; this is necessary to maintain the integrity of the standard.

Gerber Format® is a Ucamco registered trade mark. By using this document, developing software interfaces based on this format or using the name Gerber Format®, users agree not to (i) rename the Gerber Format®; (ii) associate the Gerber Format® with data that does not conform to the Gerber file format specification; (iii) develop derivative versions, modifications or extensions without prior written approval by Ucamco; (iv) make alternative interpretations of the data; (v) communicate that the Gerber Format® is not owned by Ucamco, explicitly or implied.

The material, information and instructions are provided AS IS without warranty of any kind, explicit or implied. Ucamco does not warrant, guarantee or make any representations regarding the use of the information contained herein, or the results of its use. Ucamco shall not be liable for any direct, indirect, consequential or incidental damages arising out of the use or inability to use the information contained herein.

All product names cited are trademarks or registered trademarks of their respective owners.

1.6 About Ucamco

Ucamco (former Barco ETS) is a market leader in PCB CAM software and imaging systems. We have more than 25 years of continuous experience developing and supporting leading-edge front-end tooling solutions for the global PCB industry. We help fabricators world-wide raise yields, increase factory productivity, and cut enterprise risks and costs.

Today we have more than 1000 laser photoplotters and 5000 CAM systems installed around the world with local support in every major market. Our customers include the leading PCB fabricators across the global spectrum. Many of them have been with us for more than 20 years.

Key to this success has been our uncompromising pursuit of engineering excellence in all our products. For 25 years our product goals have been best-in-class performance, long-term reliability, and continuous development to keep each user at the cutting-edge of his chosen technology.

For more information see www.ucamco.com.

2 Overview

2.1 File Structure

The Gerber format is a 2D bi-level vector image file format: the image is defined by resolution-independent graphics objects. (Bi-level or binary means that the image takes one of two values in each point, typically black or white.) A single Gerber file specifies a single image. A Gerber file is complete: it does not need external files or parameters to be interpreted. One Gerber file represents one image. One image needs one file only.

A Gerber file uses printable 7-bit ASCII characters. It is printable and human readable.

A Gerber file is a stream of *commands*. The commands create a stream of graphics objects (see 2.2) that are put on the image plane to create the final image. Other commands add attributes to structures in the image- attributes are labels defining meta-information.

A Gerber file can be processed in a single pass. Names, parameters and objects must be defined *before* they are used.

As an illustration here is a small Gerber file with one command per line. It creates a circle of 1.5 mm in the origin.

```
%FSLAX26Y26*%  
%MOMM*%  
%ADD100C,1.5*%  
D100*  
X0Y0D03*  
M02*
```

2.2 Apertures

An aperture is a 2D plane figure. Typically, apertures have the shape of a pad, such as a circle, a rectangle or a rectangle with rounded corners, but can take more complicated shapes such as a thermal pad or.

The AD (Aperture Define) command creates an aperture based on an aperture template and parameter values and gives it a unique D code or aperture number for reference later in the command stream.

There are two kinds of apertures templates:

- Standard apertures are pre-defined: the circle (C), rectangle (R), obround (O) and regular polygon (P). See 4.4.
- Macro apertures are created with the AM (Aperture Macro) command. Any shape and parametrization can be created. They are identified by their given name. (See 4.4.6).

Standard apertures can be considered as built-in macro apertures. The example AD command below creates an aperture with D-code D123. It uses the standard aperture R with parameters 2.5 and 1.5 mm which creates a rectangle of 2.5 by 1.5 mm.

```
%ADD123R,2.5X1.5*%
```

Macros are a powerful feature of the Gerber format. Templates of any shape can be created. A file writer can easily define the apertures needed. A file reader can handle any such aperture by implementing the small number of macro primitives. This single flexible mechanism replaces the need for a large - but always insufficient - set of built-in apertures. New apertures can be created without extending the format.

Block apertures are another type of apertures. They are an ordered set of graphics objects. Block apertures are not created from templates. They are created by an AB command, which defines a block and directly assigns a D-code to it (see 2.8).

An aperture has an *origin*. When an aperture is flashed, its origin is positioned at the coordinates in the D03 flash command (see 4.1). The origin of a standard aperture is its geometric center. The origin of a macro aperture is the origin used in the AM command defining the macro. The origin of a block aperture is the origin used when defining the block.

2.3 Graphics Objects

A Gerber file creates an ordered stream of graphics objects. A graphics object represents plane figure. It has a shape, a size, a position and a polarity (dark or clear). The stream of the graphics objects creates the final image by superimposing the objects on the plane in the order of the stream, with dark polarity objects darkening the plane and clear ones erasing all dark areas under them.

There are four types of graphics objects:

- ❑ **Draws** are straight-line segments, stroked with the current aperture. Circular and rectangular apertures can stroke a straight line. Thickness and draw endings depend on the current aperture: line endings are round for circle apertures and square or triangle for square apertures (see 2.4).
- ❑ **Arcs** are circular segments, stroked with the current aperture. Only a circular aperture can stroke an arc. The thickness is the diameter of the circle. Arc endings are always round as only stroking with a circle is allowed (see 2.4).
- ❑ **Flashes** are replications of the current aperture in the image plane. Any valid aperture can be flashed (see 4.8.4). An aperture is typically flashed many times.
- ❑ **Regions** areas defined by its contour (see 4.12.1). A contour is a closed sequence of connected linear or circular segments.

In PCB copper layers, tracks are typically represented by draws and arcs, pads by flashes and copper pours by regions. Tracks is then a generic name for draws and arcs.

2.4 Draws and Arcs

A *draw object* is created by a command with D01 code in linear interpolation mode. The command results in stroking a straight-line segment with a solid circle or solid rectangle standard aperture. If stroked with a circle aperture the draw has round endings and its thickness is equal to the diameter of the circle. The effect of stroking a line segment with a rectangle aperture is illustrated below.

If the rectangle aperture is aligned with the line being stroked the result is a draw with line endings which have right angles:



1. Creating a draw: the aperture is aligned with line

If the rectangle is not aligned the result is as in the illustration below. The rectangle is *not* automatically rotated to align with the line being stroked.



Line being stroked



Aperture

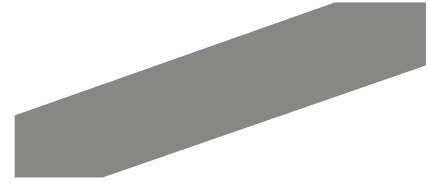

Draw

2. Creating a draw: the aperture is not aligned with line

The solid circle and the solid rectangle *standard* apertures are the only apertures allowed for creating *draw* objects. Neither other standard apertures nor any macro apertures can be used to create a draw, even if their effective shape is circle or a rectangle.

An *arc* object is created by a command with D01 code in circular interpolation mode. In this case the command results in stroking an arc segment with a solid circle standard aperture. The *arc* has round endings and its thickness is equal to the diameter of the circle. An *arc* object cannot be created using a rectangle or any other aperture.

A circle aperture with diameter zero can be used for creating a draw or an arc. It creates graphics objects without image which can be used to transfer non-image information, e.g. an outline.

Zero-length draws and arcs are allowed. The resulting image is a replica of the aperture, the limiting image when the draw/arc length approaches zero. Thus the image is what is expected if a small draw/arc is accidentally rounded to a zero-length draw/arc. Although the image is coincidentally identical to a *flash* of the same aperture the resulting graphics object is not a flash but a draw/arc. Do not use zero-length draws to represent pads. Pads must be represented by flashes for unequivocal identification.

2.5 Operations (D01, D02, D03)

D01, D02 and D03 are the *operations*. An *operation* is a command containing coordinate data followed by a single operation code: each operation code is associated with a single coordinate pair and vice versa. Operations create the graphics objects and/or change the current point by operating on the coordinate data.



Example:

```
X100Y100D01*
X200Y200D02*
X300Y-400D03*
```

The operations have the following effect.

- D02 moves the current point (see 2.5) to the coordinate pair. No graphics object is created.
- D01 creates a straight or circular line segment by interpolating from the current point to the coordinate pair. Outside a region statement (see 2.5) these segments are converted to draw or arc objects by stroking them with the current aperture (see 2.4). Within a region statement these segments form a contour defining a region (see 4.12).
- D03 creates a flash object by flashing (replicating) the current aperture. The origin of the current aperture is positioned at the specified coordinate pair.

Only D01 and D03 operation codes result in a graphics object creation. The effect of the operation codes depends on the graphics state (see 2.5).

2.6 Graphics State

The graphics state is a set of parameters affecting the result of the operation codes (see 2.5). Before an operation code is issued all graphics state parameters affecting it must be defined.

The most important graphics state parameter is the *current point*. This is a point in the image plane set implicitly by each operation command (D01, D02, D03) to the coordinates contained in that operation command after finishing.

All other graphics state parameters are set explicitly by corresponding commands. Their values remain constant until explicitly changed.

The table below lists the graphics state parameters. The column 'Constant or variable' indicates whether a parameter remains fixed during the processing of a file or whether it can be changed. The column 'Initial value' is the default value at the beginning of each file; if the default is undefined the parameter value must be explicitly set by a command in the file before it is first used.

Graphics state parameter	Value range	Constant or variable during file processing	Initial value
Coordinate parameters			
Coordinate format	Coordinate resolution. See the FS command in 4.1	Constant	Undefined
Unit	Inch or mm. See MO command in 4.2	Constant	Undefined
Generation parameters			
Current point	Point in plane	Variable	Undefined
Current aperture	Used for interpolating and flashing. See D01 and D03 commands in 4.8	Variable	Undefined

Interpolation mode	Linear, clockwise circular, counterclockwise circular See G01, G02 and G03 commands in 4.9 and 4.10	Variable	Undefined
Quadrant mode	Single-, multi-quadrant. See G74 and G75 in 4.10	Variable	Undefined
Aperture transformation parameters			
Polarity	Dark or clear. See the LP command in 4.11.2	Variable	Dark
Mirroring	See the LM command in 4.11.3	Variable	No mirror
Rotation	See the LR command in 4.11.4	Variable	No rotation
Scaling	See the LS command in 4.11.5	Variable	No scaling

Graphics state parameters

The graphics state determines the effect of an operation. If a parameter is undefined when it is required to perform an operation the Gerber file is *invalid*. A graphics state parameter that is not needed can remain undefined. For example, if the interpolation mode has been set by G02 or G03 code command (circular interpolation) the quadrant mode is required to perform a D01 code operation and thus must be defined; if the interpolation mode has been set by G01 code command (linear interpolation) then the quadrant mode is not needed and may remain undefined.

The relevance of the graphics state parameters for the operations is represented in the table below.

Graphics state parameter	Operation codes		
	D01	D02	D03
Coordinate format	Yes	Yes	Yes
Unit	Yes	Yes	Yes
Current point	Yes (interpolation starting point)	No	No
Current aperture	Yes outside a region statement, no inside	No	Yes
Interpolation mode	Yes	No	No
Quadrant mode	Yes if interpolation mode is clockwise or counterclockwise circular interpolation No if interpolation mode is linear	No	No
Polarity	Yes	No	Yes
Mirroring	Yes	No	Yes
Rotation	Yes	No	Yes

Scaling	Yes	No	Yes
----------------	-----	----	-----

Relevance of graphics state parameters for operation codes

If a table cell contains 'Yes' it means the graphics state parameter is relevant for the corresponding operation. Thus the graphics state parameter must be defined before the operation code is used in the file. If the parameter does not have an automatically assigned initial value it must be explicitly set by the corresponding command.

2.7 Polarity

The final image of the Gerber file is created by superimposing the objects in the order of their creation. Objects have a polarity, either clear or dark. Objects can overlap. A dark polarity object darkens its image in the plane. A clear polarity object clears its image in *all objects beneath it (generated before)*. Subsequent dark objects may again darken the cleared area. See illustration below. Another example is in 4.12.4.7.

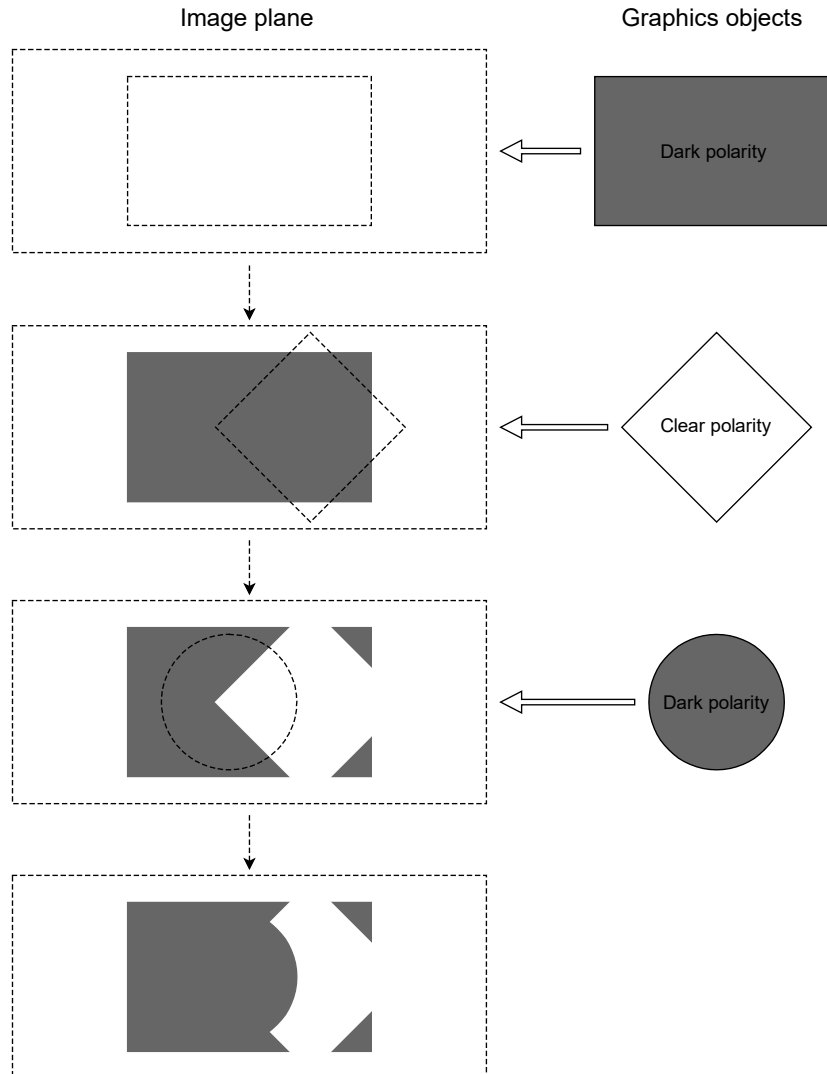

3. Superimposing objects with dark and clear polarities

An object is totally dark or totally clear. It cannot be partially dark and partially clear.

The *order* of superimposed objects with different polarities affects the final image.

The LP command sets the polarity mode, a graphics state parameter (see 4.11). Objects that are created when the polarity mode is dark are dark; when the mode is clear the objects are clear.

2.8 Blocks

A *block* is a substream of graphics objects that can be added one or more times to the final graphics objects stream. Blocks can be mirrored, rotated, scaled, shifted and its polarity can be toggled. By using blocks sub-images that occur multiple times must only be defined once, thus slashing file size, boosting processing speed and preserving the information that these sub-images are identical.

A block is *not* a macro of commands called repeatedly in the command stream. The command stream is processed sequentially, in one pass, without procedure or macro calls. Gerber is not a programming language.

Blocks can contain objects with different polarities (LPD and LPC). Blocks can overlap.

The origin of the block is the (0, 0) point of the file coordinate space.

Once a block is added to the graphics objects stream its objects becomes part of the overall stream. The effect of these objects does not depend on whether they were part of a block or not. Only their order is important. A clear object in a block clears *all* objects beneath it, not only the objects *not* contained in the block.

There are two commands to create a block: SR and AB.

2.9 Attributes

Attributes add meta-information to a Gerber file. These are akin to labels providing additional information about the file or features within. Examples of such meta-information are:

- The function of the file: is it the top solder mask, or the bottom copper layer etc.
- The function of a pad: is the pad a component pad, or a via pad, or a fiducial, etc.



Example:

This command defines an attribute indicating the file represents the top solder mask.

```
%TF.FileFunction,Soldermask,Top*%
```

Attributes do not affect the image. A Gerber reader will generate the correct image even if it simply ignores the attributes.

Attributes can be attached to objects, apertures or to the complete file.

The attribute syntax provides a flexible and standardized way to add meta-information to the images, independent of the specific semantics or application.

Attributes are needed when PCB data is transferred from design to fabrication. The PCB fabricator needs more than just the image: for example, he needs to know what are the via pads to manufacture the solder mask. The attributes transfer the design intent from CAD to CAM in an unequivocal and standardized manner. This is sometimes rather grandly called “adding intelligence to the image”. Without these attributes the fabricator must reverse engineer the design intent of the features in the file, which is a time-consuming and error-prone process.

Gerber files containing attribute commands (TF, TA, TO, TD) are called Gerber X2 files, files without attributes Gerber X1 files.

Attributes are described in detail in the chapter 5.

2.10 Table with Commands

Command	Description	Section
FS	Format specification. Sets the coordinate format, e.g. the number of decimals.	4.1
MO	Mode. Sets the unit to inch or mm.	4.2
AD	Aperture define. Defines a template based aperture and assigns a D code to it.	4.3
AM	Aperture macro. Defines a macro aperture template.	4.5
AB	Aperture block. Defines a block aperture and assigns a D-code to it.	4.6
Dnn (nn≥10)	Sets the current aperture to D code nn.	4.7
D01	Interpolate operation. Outside a region statement D01 creates a draw or arc object using the current aperture. Inside it creates a linear or circular contour segment. After the D01 command the current point is moved to draw/arc end point.	4.8
D02	Move operation. D02 does not create a graphics object but moves the current point to the coordinate in the D02 command.	4.8
D03	Flash operation. Creates a flash object with the current aperture. After the D03 command the current point is moved to the flash point.	4.8
G01	Sets the interpolation mode to linear.	4.9
G02	Sets the interpolation mode to clockwise circular.	4.10
G03	Sets the interpolation mode to counterclockwise circular.	4.10
G74	Sets quadrant mode to single quadrant.	4.10
G75	Sets quadrant mode to multi quadrant.	4.10
LP	Load polarity. Loads the polarity object transformation parameter.	4.11.2
LM	Load mirror. Loads the mirror object transformation parameter.	4.11.3
LR	Load rotation. Loads the rotation object transformation parameter.	4.11.4
LS	Load scale. Loads the scale object transformation parameter.	4.11.5
G36	Starts a region statement. This creates a region by defining its contour.	4.12.
G37	Ends the region statement.	4.12
SR	Step and repeat. Open or closes a step and repeat statement.	4.13
G04	Comment.	4.14
TF	Attribute file. Set a file attribute.	5.2
TA	Attribute aperture. Add an aperture attribute to the dictionary or modify it.	5.3
TO	Attribute object. Add an object attribute to the dictionary or modify it.	5.4
TD	Attribute delete. Delete one or all attributes in the dictionary.	5.5
M02	End of file.	4.15

Command Overview

2.11 Processing a Gerber File

The image below illustrates how a Gerber file is processed.

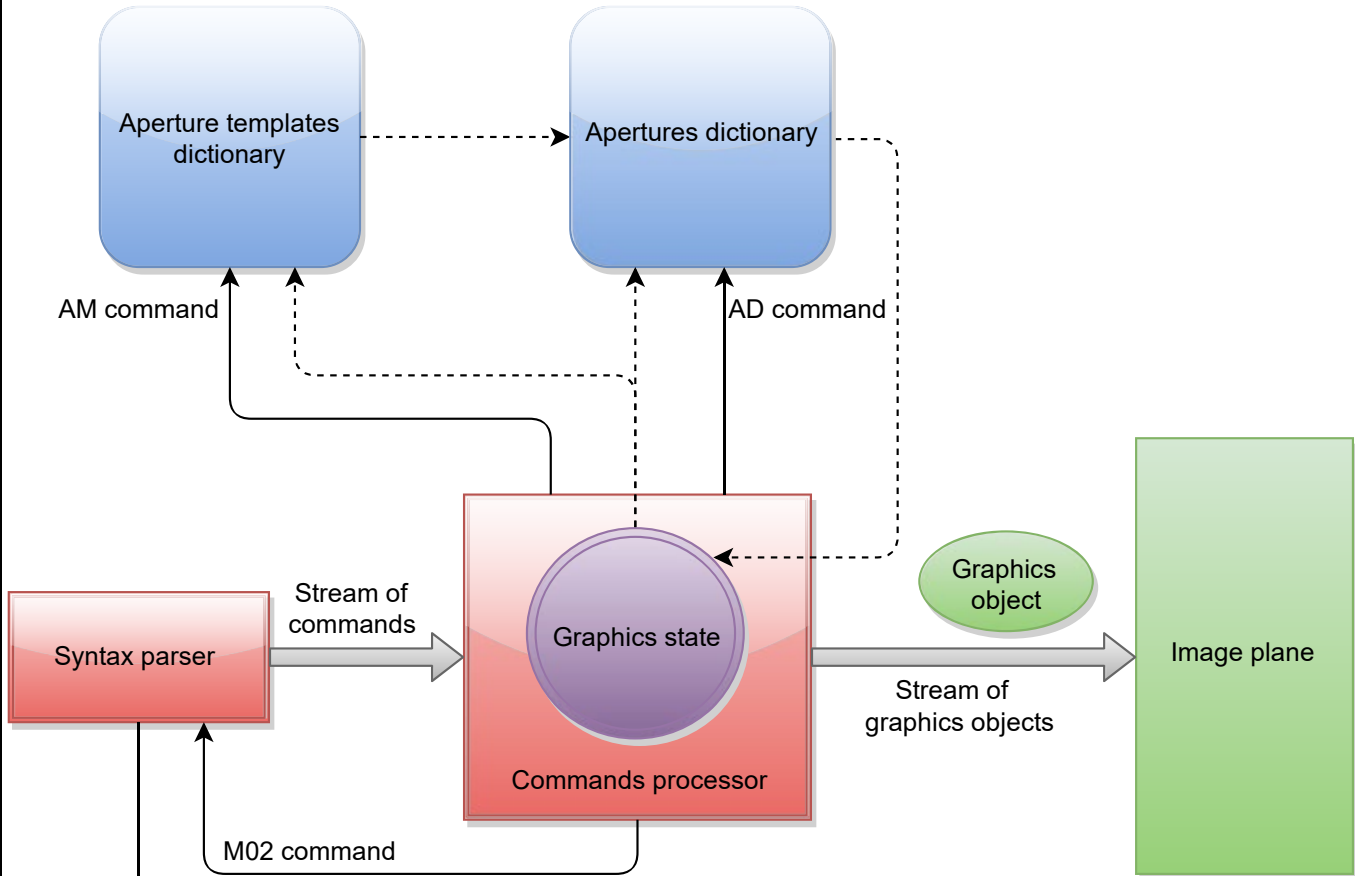

Legend

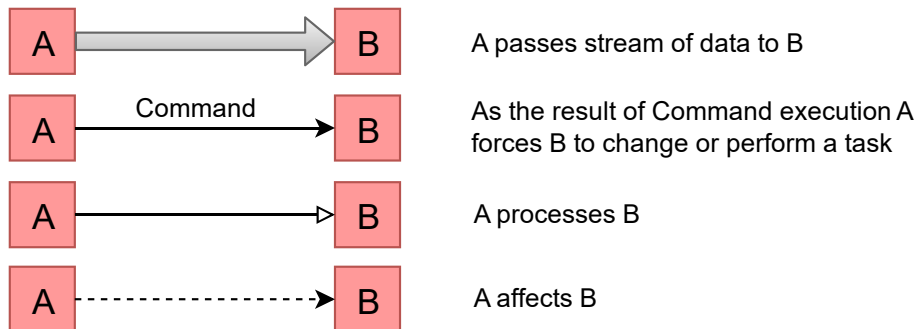

4. Gerber file processing diagram

The syntax parser reads the Gerber file and produces the stream of commands for the commands processor. The commands processor is responsible for handling the stream of commands and as the result it generates the stream of graphics objects. All the created objects are superimposed on the image plane in order of their creation.

The *graphics state* is a core part of the commands processor. How the processor creates graphics objects from the operation codes (see 2.5) depends on the graphics state. Conversely, the processor modifies the graphics state when processing certain commands (see 2.5).

The aperture template dictionary holds all the templates available. The AD command (see 4.3) instantiates the templates to apertures and adds them to the aperture library. Standard, or built-in, aperture templates are automatically added to the dictionary when file processing is started. Macro aperture templates are created with an AM command (see 4.5); they are added when the AM command is processed.

The *current aperture* is a graphics state parameter that is maintained by Dnn command (see 4.7). When the processor executes a Dnn command a referenced aperture from apertures dictionary is set as the current aperture.

The graphics state also affects the generation of aperture templates and apertures: the templates and apertures depend on 'coordinate format' and 'unit' graphics state parameters (see 2.5).

The graphics object stream is without state. Objects are superimposed as they are, in their order of appearance.

After processing the M02 command (see 4.14) the processor interrupts the syntax parser and stops the graphics objects generation.

The image from above illustrates the processing of a Gerber file without attributes.

2.12 Glossary

AB statement: A statement defining a block aperture.

Aperture: A 2D shape that is used for stroking or flashing. (The name is historic; vector photoplotters exposed images on lithographic film by shining light through an opening, called aperture.)

Aperture macro: The content of an Aperture Macro (AM) command. Defines a custom aperture template by combining built-in primitives.

Aperture template: A template is used to create the specific apertures used in the file. The AD command defines the parameters to instantiate the template to a defined aperture. There are three types of templates: standard or built-in apertures, macro apertures and block apertures.

Aperture templates dictionary: The object that holds all the aperture templates.

Apertures dictionary: The object that holds all the apertures.

Arc: A graphics object created by a D01 command in a circular interpolation mode.

Attribute: Metadata that is attached to the file or to objects in it; it provides extra information without affecting the image.

Attributes dictionary: The object that holds all the current attributes during the processing of a Gerber file.

Bi-level image: A two-dimensional (2D) image represented by two colors, usually black and white.

Block: A substream of graphics objects that can be added to the final objects stream.

Circular interpolation: Creating a circular segment (circular arc) that is either an arc graphics object or used as a circular contour segment.

Clear: Clearing or erasing part of the image in the image plane. When a graphics object with clear polarity is added to the stream it erases its shape from any image that was already there.

Command: Commands are the basic unit of a Gerber file. Commands create graphics objects, define apertures, manage attributes, modify the graphics state and so on. For historic reasons, there are two syntax styles for commands: function code commands and extended commands.

Command code: A code that identifies the command.

Contour: A closed a sequence of connected linear or circular segments. Contours are used to create regions or outline primitives in macro apertures.

Coordinate data: A number whose interpretation is determined by the FS command. It is used to specify the X and Y coordinates of a point in the image plane and a distance or offset in the X and Y direction.

Coordinate format: The specification of how to convert coordinate data to coordinates. It is file-dependent and is defined by an FS command.

Current aperture: The graphics state parameter that specifies the last aperture selected by a Dnn command. The current aperture is always used to create flashes, draws and arcs.

Current point: The graphics state parameter that specifies the point in the plane used as a begin point of a circular or linear interpolation or as the location flash.

Darken: Darken the shape of a graphics object on the image plane; this happens when a graphics object with dark polarity added to the image.

Data block: The low level syntactical element of a Gerber file that is represented by a sequence of characters ending with '*' character. Data blocks are used to build commands. Many commands consist of a single data block.

Draw: A graphics object created by D01 code command in linear interpolation mode.

Extended commands: Commands enclosed in a pair of '%' characters.

File image: The bi-level image that is the visual representation of a Gerber file. It is created by superimposing the graphics objects in the plane.

Flash: A graphics object created by D03 or flash command.

Function code commands: Commands consisting of a single data block containing a function code. A function code is a letter 'D', 'G' or 'M' followed by a code number.

Gerber file: A file in the Gerber format.

Gerber format: The vector image file format defined by the current specification and used for representing a bi-level image.

Graphics object: A graphics object is a 2D object with a shape, a size, a position in the plane and a polarity (dark or clear). It is of one of the following types: flash, draw, arc or region. The file image is created by superimposing graphics objects on the image plane. Attributes can optionally be attached to a graphics object.

Graphics state: The set of parameters that at each moment determine how the operation codes create graphics objects. For example, it determines whether a D01 operation code creates a draw or an arc.

Header: The part of the file from the file beginning to the point where the first operation code is encountered. The header typically holds the definitions of file attributes, aperture definitions, scale and unit.

Image plane: The 2D plane in which the image defined by the file is created.

Interpolation mode: The graphics state parameter defining the current interpolation mode. See linear and circular interpolation.

Linear interpolation: Creating a straight segment that is either converted to a draw graphics object or used as a linear contour segment.

Macro aperture: An aperture template defined using AM command.

Multi quadrant mode: A mode defining how circular interpolation is performed. In this mode a circular arc is allowed to extend over more than 90°. If the start point of the arc is equal to the end point the arc is a full circle of 360°.

Operation: A command containing one of the operation codes D01, D02 or D03 and coordinate data. The operation code defines the type of the operation that is performed

using the coordinate data. Operations may create graphics objects, create contours, and change the current point of the graphics state.

Polarity: A graphics state parameter that can take the value dark or clear. It determines the polarity of the graphics objects generated. Dark means that the object marks the image plane in dark and clear means that the object clears or erases everything underneath it. See also 'Darken' and 'Clear'.

Quadrant mode: The graphics state parameter defining the current quadrant mode. See multi quadrant mode and single quadrant mode.

Region: A graphics object with an arbitrary shape defined by its contour.

Region statement: A statement creating a region by defining its contour.

Resolution: The distance expressed by the least significant digit of coordinate data. Thus the resolution is the step size of the grid on which all coordinates are defined.

Single quadrant mode: A mode defining how circular interpolation is performed. In this mode a circular arc cannot extend over more than 90°. If the start point of the arc is equal to the end point, the arc has length zero, i.e. covers 0°.

SR statement: A statement defining a block and step & repeating it.

Standard aperture: A built-in aperture template.

Standard attribute: A built-in attribute with a pre-defined semantics. See also user attribute.

Statement: A coherent sequence of commands delimited by an open and close command defining a higher-level structure (block or region).

Stroke: To create a draw or an arc graphics object using the current aperture.

Track: Either a draw or an arc. Typically used for a conductive traces on a PCB.

Unit: The measurement unit 'mm' or 'inch' used to interpret the coordinate data. The effective unit is stored as the value of the corresponding graphics state parameter.

User attribute: A third-party defined attribute to extend the format with proprietary meta-information.

2.13 Example Files

These annotated sample files illustrate the use of the elements of the Gerber file format. They will give you a feel for the Gerber file format if it is new to you and thus will make the formal specification easier to read.

2.13.1 Example: Two Square Boxes

This example represents a single polarity image with two square boxes.

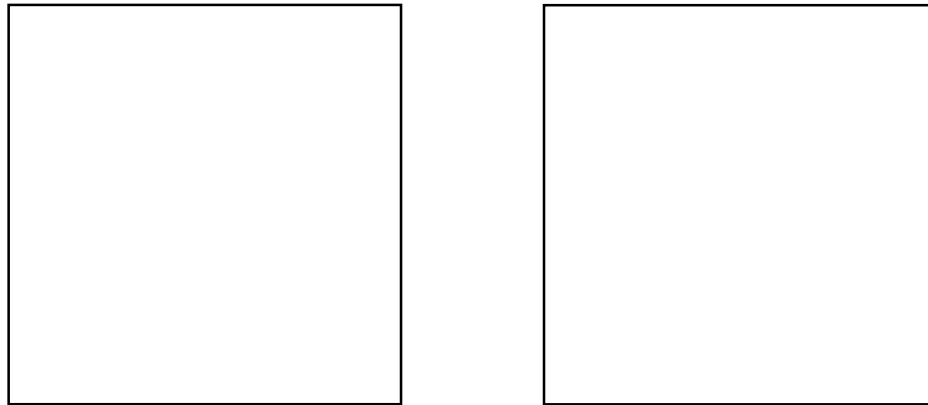

5. Example: two square boxes

Syntax	Comments
G04 Ucamco ex. 1: Two square boxes*	A comment
%FSLAX25Y25*%	Coordinate format specification: Leading zero's omitted Absolute coordinates Coordinates format is 2.5: 2 digits in the integer part 5 digits in the fractional part
%MOMM*%	Unit set to mm
%TF.Part,Other,example*%	Attribute: the file does not describe a PCB part - it is just an example
%LPD*%	Set the polarity to dark
%ADD10C,0.010*%	Define aperture with D-code 10 as a 0.01 mm circle
D10*	Set aperture with D-code 10 as current aperture
X0Y0D02*	Set current point to (0, 0)
G01*	Set linear interpolation mode
X500000Y0D01*	Create draw graphics object using the current aperture D10: start point is the current point (0,0), end point is (5, 0)
Y500000D01*	Create draw using the current aperture: (5, 0) to (5, 5)

Syntax	Comments
X0D01*	Create draw using the current aperture: (5, 5) to (0, 5)
Y0D01*	Create draw using the current aperture: (0, 5) to (0, 0)
X600000D02*	Set current point to (6, 0)
X1100000D01*	Create draw using the current aperture: (6, 0) to (11, 0)
Y500000D01*	Create draw using the current aperture: (11, 0) to (11, 5)
X600000D01*	Create draw using the current aperture: (11, 5) to (6, 5)
Y0D01*	Create draw using the current aperture: (6, 5) to (6, 0)
M02*	End of file

2.13.2 Example: Polarities and Apertures

This example illustrates the use of polarities and various apertures.

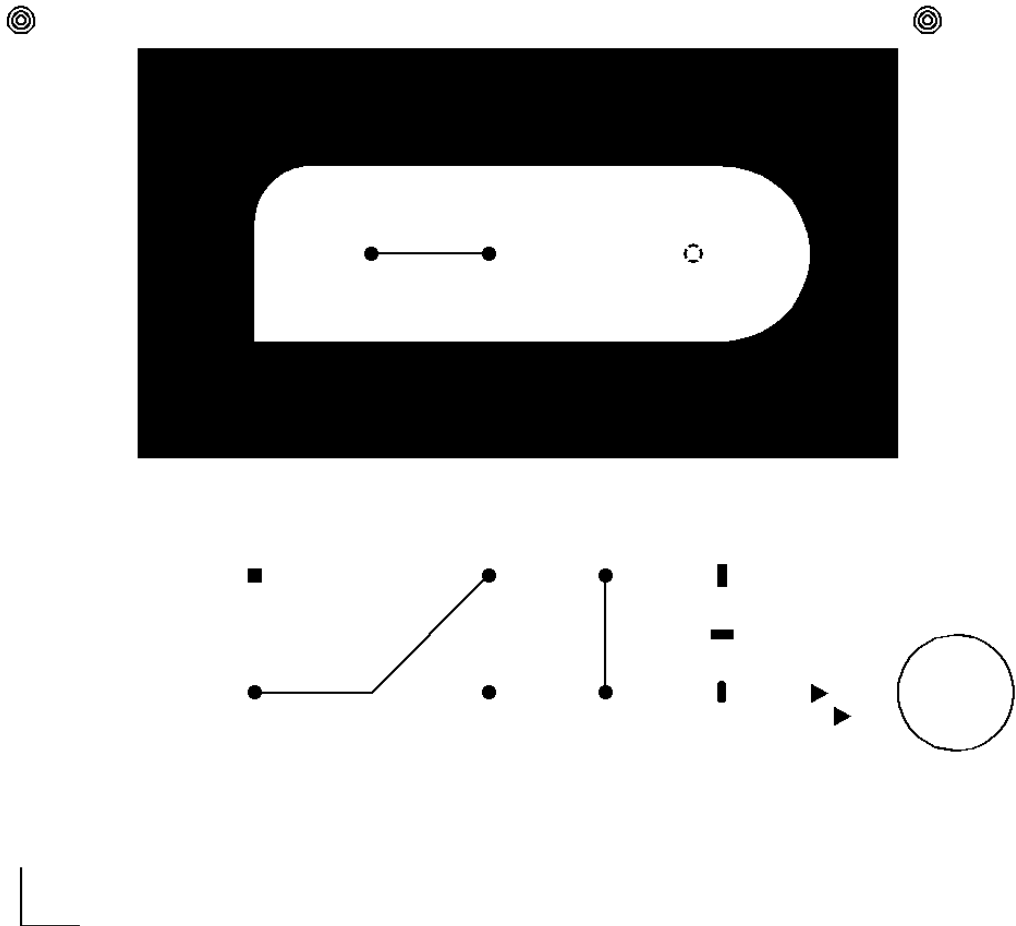

6. Example: various shapes

Syntax	Comments
G04 Ucamco ex. 2: Shapes*	A comment
%FSLAX26Y26*%	Format specification: Leading zero's omitted Absolute coordinates Coordinates format is 2.6: 2 digits in the integer part 6 digits in the fractional part
%MOIN*%	Units are inches
%TF.Part,Other,Example*%	Attribute: the file is not a layer of a PCB part - it is just an example
G04 Define Apertures*	Comment
%AMTARGET125*	Define the aperture macro 'TARGET125'
6,0,0,0.125,.01,0.01,3,0.003,0.150,0*%	Use moiré primitive in the macro
%AMTHERMAL80*	Define the aperture macro 'THERMAL80'
7,0,0,0.080,0.055,0.0125,45*%	Use thermal primitive in the macro
%ADD10C,0.01*%	Define the aperture: D10 is a circle with diameter 0.01 inch
%ADD11C,0.06*%	Define the aperture: D11 is a circle with diameter 0.06 inch
%ADD12R,0.06X0.06*%	Define the aperture: D12 is a rectangle with size 0.06 x 0.06 inch
%ADD13R,0.04X0.100*%	Define the aperture: D13 is a rectangle with size 0.04 x 0.1 inch
%ADD14R,0.100X0.04*%	Define the aperture: D14 is a rectangle with size 0.1 x 0.04 inch
%ADD15O,0.04X0.100*%	Define the aperture: D15 is an obround with size 0.04 x 0.1 inch
%ADD16P,0.100X3*%	Define the aperture: D16 is a polygon with 3 vertices and circumscribed circle with diameter 0.1 inch
%ADD18TARGET125*%	Define the aperture: D18 is the instance of the macro aperture called 'TARGET125' defined earlier
%ADD19THERMAL80*%	Define the aperture: D19 is the instance of the macro aperture called 'THERMAL80' defined earlier
G04 Start image generation*	A comment
D10*	Set the current aperture: use aperture with D-code 10
X0Y250000D02*	Set the current point to (0, 0.25) inch
G01*	Set linear interpolation mode
X0Y0D01*	Create draw using the current aperture

Syntax	Comments
X250000Y0D01*	Create draw using the current aperture
X1000000Y1000000D02*	Set the current point
X1500000D01*	Create draw using the current aperture
X2000000Y1500000D01*	Create draw using the current aperture
X2500000Y1500000D02*	Set the current point.
X2500000Y1000000D01*	Create draw using the current aperture
D11*	Set the current aperture: use aperture with D-code 11
X1000000Y1000000D03*	Create flash using the current aperture D11 at (1.0, 1.0). Y is modal.
X2000000D03*	Create flash using the current aperture D11 at (2.0, 1.0). Y is modal.
X2500000D03*	Create flash using the current aperture D11 at (2.5, 1.0). Y is modal.
Y1500000D03*	Create flash using the current aperture D11 at (2.5, 1.5). X is modal.
X2000000D03*	Create flash using the current aperture D11 at (2.0, 1.5). Y is modal.
D12*	Set the current aperture: use aperture with D-code 12
X1000000Y1500000D03*	Create flash using the current aperture at (1.0, 1.5)
D13*	Set the current aperture: use aperture with D-code 13
X3000000Y1500000D03*	Create flash using the current aperture at (3.0, 1.5)
D14*	Set the current aperture: use aperture with D-code 14
Y1250000D03*	Create flash using the current aperture at (3.0, 1.25)
D15*	Set the current aperture: use aperture with D-code 15
Y1000000D03*	Create flash using the current aperture at (3.0, 1.0)
D10*	Set the current aperture: use aperture with D-code 10
X3750000Y1000000D02*	Set the current point. This sets the start point for the following arc object
G75*	Set multi quadrant mode
G03*	Set counterclockwise circular interpolation mode
X3750000Y1000000I250000J0D01*	Create arc using the current aperture D10. This creates a complete circle
D16*	Set the current aperture: use aperture with D-code 16
X3400000Y1000000D03*	Create flash using the current aperture D16
X3500000Y900000D03*	Create flash using the current aperture D16 again

Syntax	Comments
D10*	Set the current aperture: use aperture with D-code 10
G36*	Start a region statement
X500000Y200000D02*	Set the current point to (0.5, 2.0)
G01*	Set linear interpolation mode
X500000Y375000D01*	Create linear segment of the contour
X3750000Y375000D01*	Create linear segment of the contour
X3750000Y200000D01*	Create linear segment of the contour
X500000Y200000D01*	Create linear segment of the contour
G37*	Close the region statement
	This creates the region by filling the created contour
D18*	Set the current aperture: use aperture with D-code 18
X0Y387500D03*	Create flash using the current aperture D18
X3875000Y387500D03*	Create flash using the current aperture D18
%LPC*%	Set the polarity to clear
G36*	Start the region statement
X1000000Y250000D02*	Set the current point to (1.0, 2.5)
X1000000Y300000D01*	Create linear segment
G74*	Set single quadrant mode
G02*	Set clockwise circular interpolation mode
X1250000Y3250000I250000J0D01*	Create clockwise circular segment with radius 0.25
G01*	Set linear interpolation mode
Y3250000X300000D01*	Create linear segment
G75*	Set multi quadrant mode
G02*	Set clockwise circular interpolation mode
X3000000Y2500000I0J-375000D01*	Create clockwise circular segment with radius 0.375
G01*	Set linear interpolation mode
Y2500000X1000000D01*	Create linear segment
G37*	Close the region statement
	This creates the region by filling the created contour
%LPD*%	Set the polarity to dark
D10*	Set the current aperture: use aperture with D-code 10
X1500000Y2875000D02*	Set the current point
X2000000 Y2875000D01*	Create draw using the current aperture

Syntax	Comments
D11*	Set the current aperture: use aperture with D-code 11
X1500000Y2875000D03*	Create flash using the current aperture D11
X2000000Y2875000D03*	Create flash using the current aperture D11
D19*	Set the current aperture: use aperture with D-code 19
X2875000Y2875000D03*	Create flash using the current aperture D19
M02*	End of file

2.13.3 Example: A Drill File

This example is a drill file.

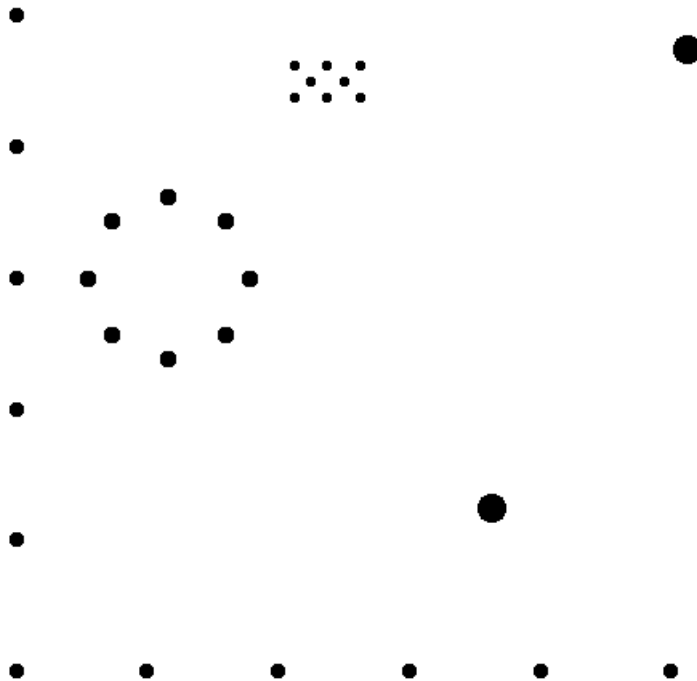

7. Example: drill file

Syntax	Comments
%FSLAX26Y26*%	Format specification: Leading zero's omitted Absolute coordinates Coordinate format is 2.6: 2 digits in the integer part 6 digits in the fractional part

Syntax	Comments
%MOIN*%	Units are inches
%TF.FileFunction,Plated,1,8,PTH*%	Attribute: this drill file describes plated-through holes
%TF.Polarity,Positive*%	Always positive polarity for drill files
%TF.Part,Single*%	Attribute: the file is part of a single PCB
%LPD*%	Set the polarity to dark
%TA.DrillTolerance,0.002,0.001*%	Set the drill tolerance attribute to 2 mil in plus and 1 mil in minus in the attribute dictionary. It will be attached to all aperture definitions until changed or deleted
%TA.AperFunction,ComponentDrill%	Attribute indicates that the following apertures define component drill holes.
%ADD10C,0.014000*%	Define the aperture: a plated hole for a component lead, with 14 mil end (or inner) diameter and 2 mil positive and 1 mil negative tolerance.
%TA.AperFunction,Other,SpecialDrill*%	Attribute indicates that the following apertures are special drill holes
%ADD11C,0.024000*%	Define the aperture: a plated hole for a special purpose, with 24 mil end (or inner) diameter and 2 mil positive and 1 mil negative tolerance.
%TA.DrillTolerance,0.015,0.015*%	Change the drill tolerance attribute for the following apertures to 15 mil in both directions
%TA.AperFunction,MechanicalDrill*%	Change the tool function attribute in the dictionary to mechanical
%ADD12C,0.043000*%	Define the aperture: a circular aperture defining a plated mechanical drill hole with 43 mil end diameter, and a tolerance of 15 mil in both directions.
%ADD13C,0.022000*%	Define the aperture: another tool with the same attributes but a smaller end diameter
%TD.AperFunction*%	Remove the .AperFunction aperture attribute from the attributes dictionary
%TD.DrillTolerance*%	Remove the .DrillTolerance aperture attribute from the attributes dictionary
G01*	Set linear interpolation mode
D10*	Set the current aperture: use drill tool 10
X242000Y275000D03*	Create several flash graphics objects using the current aperture D10: drill plated component drill holes with diameter 14 mil at indicated coordinates
X242000YY325000D03*	
X217000Y300000D03*	
X192000Y325000D03*	
X292000Y275000D03*	
X192000Y275000D03*	
X292000Y325000D03*	
X292000Y325000D03*	

Syntax	Comments
X267000Y300000D03*	
D11*	Set the current aperture: use drill tool 11
X124000Y0D03*	Create several flash graphics objects using the current aperture D11: drill plated special drill holes with diameter 24 mil at indicated coordinates
X0Y-124000D03*	
X-124000Y0D03*	
X88000Y88000D03*	
X-88000Y88000D03*	
X0Y124000D03*	
X88000Y-88000D03*	
X-88000Y-88000D03*	
D12*	Set the current aperture: use drill tool 12
X792000Y350000D03*	Create several flash graphics objects using the current aperture D12: drill plated mechanical drill holes with diameter 43 mil at indicated coordinates
X492000Y-350000D03*	
D13*	Set the current aperture: use drill tool 13
X767000Y-600000D03*	Create several flash graphics objects using the current aperture D13: drill plated mechanical drill holes with diameter 22 mil at indicated coordinates
X567000Y-600000D03*	
X-233000Y200000D03*	
X-233000Y400000D03*	
X-233000Y0D03*	
X-233000Y-200000D03*	
X-233000Y-600000D03*	
X-233000Y-400000D03*	
X-33000Y-600000D03*	
X167000Y-600000D03*	
X367000Y-600000D03*	
%TF.MD5,b5d8122723797ac635a1814c04c6372b%	Attribute: the MD5 checksum of the file
M02*	End of file



Note: One might be surprised to see drill files represented as Gerber files. Gerber is indeed not suited to drive drilling machines, but it is the best format to convey drill information from design to fabrication. After all, it defines where material must be removed, and this is image information that Gerber files describe perfectly. For more information, see 5.6.2.

2.14 Conformance

A file violating any requirement of the specification or containing any  part is wholly invalid. If the interpretation of a construct is not specified or not obvious the construct is invalid. An invalid Gerber file is meaningless and does *not* represent an image.

A conforming Gerber file writer must write files according to this specification. A current conforming Gerber file writer cannot use deprecated constructs. A writer is not required to consider limitations or errors in particular readers. The writer may assume that a valid file will be processed correctly.

A conforming Gerber file reader must render a valid Gerber file according to this specification. A current reader may support some or all deprecated format elements as they can be present in legacy files. To prepare for future extensions of the format, a Gerber file reader *must* give a warning when encountering an unknown command or macro primitive; it must then continue processing ignoring the unknown construct. Otherwise there is *no* mandatory behavior on reading an invalid Gerber file. It is *not* mandatory to report any other errors – this would impose an unreasonable burden on readers and may result in useless messages in some applications. It is allowed to generate an image on an invalid file, e.g. as a diagnostic help or to reverse engineer the intended image; however, as an invalid Gerber file is meaningless, it cannot be stated interpretation of the file is valid and another invalid.

The responsibilities are obvious and plain. Writers must write valid and numerically robust files and readers must process such files correctly. Writers are not responsible to navigate around problems in the readers, nor are readers responsible to solve problems in the writers. Keep in mind Postel's rule: *"Be conservative in what you send, be liberal in what you accept."*

Standard Gerber (RS-274-D) is obsolete and therefore non-conforming. The responsibility for misunderstandings of its non-standardized wheel file rests solely with the party that decided to use Standard Gerber rather than Extended Gerber. See 7.10.

This document is the sole specification of the Gerber format. Gerber viewers, however useful, do not overrule this document.

3 Syntax

3.1 Conventions for Syntax Rules

The syntax is expressed in Backus-Naur form:

- Syntax rules are written with bold font, e.g. **<elements set> = {<elements>}**
- Optional items enclosed in square brackets, e.g. **[<optional element>]**
- Items repeating zero or more times are enclosed in braces, e.g. **<elements set> = <element>{<element>}**
- Alternative choices are separated by the '|' character, e.g. **<option A>|<option B>**
- Grouped items are enclosed in regular parentheses, e.g. **(A|B)(C|D)**

Examples of Gerber file content are written with mono-spaced font, e.g. X0Y0D02*.

3.2 File Extension, MIME Type and UTI

The Gerber Format has a standard file name extension, a registered mime type and a UTI definition.

Standard file extension: .gbr or .GBR

Mime type: application/vnd.gerber

(see <http://www.iana.org/assignments/media-types/application/vnd.gerber>)

Mac OS X UTI:

```
<key>UTExportedTypeDeclarations</key>
<array>
  <dict>
    <key>UTTypeIdentifier</key>
    <string>com.ucamco.gerber.image</string>
    <key>UTTypeReferenceURL</key>
    <string>http://www.ucamco.com/gerber</string>
    <key>UTTypeDescription</key>
    <string>Gerber image</string>
    <key>UTTypeConformsTo</key>
    <array>
      <string>public.plain-text</string>
      <string>public.image</string>
    </array>
    <key>UTTypeTagSpecification</key>
    <dict>
      <key>public.filename-extension</key>
      <array>
        <string>gbr</string>
      </array>
      <key>public.mime-type</key>
      <string>application/vnd.gerber</string>
    </dict>
  </dict>
</array>
```

3.3 Character Set

A Gerber file is expressed in the 7-bit ASCII codes 32 to 126 (i.e. the printable characters in ANSI X3.4-1986) plus codes 10 (LF, Line Feed) and 13 (CR, Carriage Return). No other characters are allowed. Gerber files are therefore printable and human readable.

The line separators CR and LF have no effect, they can be ignored when processing the file. They are used to improve human readability.

Space characters can *only* be used inside strings (see 3.6.6).

Gerber files are case-sensitive. Command codes must be in upper case.

3.4 Data Blocks

Data blocks are the building blocks for a Gerber file. Each data block ends with the end-of-block character asterisk '*'. A data block may contain a function code, coordinate data, aperture primitive description, variable definition and so on.

<Data block> = {<Character>}*



Example:

```
G01*  
X50000Y3200D01*  
1, 1, $1, $2, $3*  
$4=$1x0.75*
```



Tip: One of the strengths of the Gerber format is its human readability. Use line breaks to enhance readability; put one command per line; avoid lines longer than a page width. Do not put a needless line separator within a data block, except after a comma separator in long data blocks.

3.5 Commands

3.5.1 Command Syntax Overview

Commands are higher level semantic elements of a Gerber file. Commands define the graphics state, create graphics objects, defines apertures, manage attributes and so on. A Gerber file consists of a stream of commands. There is no limitation on the number of commands.

For historic reasons, there are two command syntax styles: function code commands and extended commands.

Command syntax:

<Command> = <Function code command>|<Extended command>

<Function code command> = <Data block>

<Extended command> = %<Data block>{<Data block>}%

All extended command except the AM consist of a single data block.

The example below shows the stream of Gerber file commands of different types.



Example:

```
G04 Beginning of the file*
%FSLAX65Y26*%
%MOIN*%
%LPD*%
%ADD10C,0.000070*%
X123500Y001250D02*
...
M02*
```

3.5.2 Function Code Commands

Function code commands are identified by a code letter G, D or M followed by a code number, e.g. G02.

A code number is a positive integer number without preceding '+'. The available code numbers are described in this specification. A code number can be padded with leading zeros, but the resulting number record must not contain more than 10 digits.



Example:

```
X100Y125D1*
X100Y125D01*
X100Y125D0001*
G002*
G0000074*
```

The conventional representation of a code number contains exactly two digits, so if the number is less than 10, it is padded with one leading zero. This representation is used everywhere in the specification.



Example:

```
X100Y125D01*
```

```
X100Y125D02*  
G01*  
G74*
```

The codes D01, D02, D03 have a special function and are called operation codes. They are used together with coordinate data to form commands called *operations*.

In the example below the command consists of a single data block with D01 function code together with a coordinate pair and offset in X and Y.



Example:

```
X0Y100I-400J100D01*
```

Each operation must end with one and only one operation code. The operation code defines how the preceding coordinate data is used.

In the next example there are two operations. The first operation sets the current point to (300, 200). The second operation creates a graphics object (arc or draw, depending on the interpolation mode) from the current point to the end point (1100, 200).



Example:

```
X300Y200D02*  
X1100Y200D01*
```

Operations are described in detail in chapter 4.1. Other function code commands are described in chapters from 4.7 to 4.14.

3.5.3 Extended Commands

Extended commands are responsible for setting graphics state parameters, defining macro aperture templates and instantiating apertures, manipulating attributes.

Extended commands affecting the entire image must be placed in the header of the file. Other extended commands are placed at the appropriate location.

An extended command consists of a two-character command code followed by command data. The command code identifies the command. The structure and meaning of the command data depends on the command code.

An extended command is enclosed into a separate pair of delimiter '%' characters. Usually a command consists of a single data block ending with a '*'. The AM command however can include more than one data block.

The '%' must immediately follow the '*' of the last data block without intervening line separators. This is an exception to the general rule that a data block can be followed by a line separator.



Example:

```
%FSLAX24Y24*%  
%AMDONUTFIX*1,1,0.100,0,0*1,0,0.080,0,0*%
```

There can be only one extended command between each pair of '%' delimiters. It is allowed to put line separators between data blocks of a single command.

The following example is an AM function code command built of three data blocks.



Example:

```
%AMDONUTFIX*
1,1,0.100,0,0*
1,0,0.080,0,0*%
```



Tip: For readability it is recommended to put one data block per line in the AM command.

The syntax for an individual extended command is:

<Command> = <Command code><Command data>{*<Additional command data>*}

Syntax	Comments
Command code	2-character code (AD, AM, FS, etc...)
Command data	The data necessary for the command. Normally it includes: required modifiers: must be entered to complete definition optional modifiers: may be necessary depending on the required modifiers
Additional command data	Additional command data in the extra data blocks (used for AM command only)

We distinguish two *classes* of extended commands:

- ❑ Graphics commands affect the image generation. They define how the function codes and coordinates are processed. The graphics commands are described in the section 4.
- ❑ Attribute commands do not affect the image generation but attach attributes to either the image as a whole or to the individual graphics objects. The attribute commands are described in the section 5.

3.6 Data Types

3.6.1 Integers

Integers are a sequence of one or more digits optionally preceded by a '+' or '-' sign. They must fit in a 32 bit signed integer.

3.6.2 Decimals

Decimals are a sequence of one or more digits with an optional decimal point optionally preceded by a '+' or a '-' sign. They must fit in an IEEE double.

3.6.3 Coordinate Data

Coordinate data is used to express coordinates in operation commands.

Coordinate data is string of one or more digits representing a fixed-point decimal number. Explicit decimal points are not allowed. Leading zeroes may be omitted, as in human number writing. The FS command - see 4.1 - specifies the max number of integer (I) and decimal (D) digits. I and D must each be ≤ 6 . Signs are allowed; the '+' sign is optional. Coordinate data must have at least one digit - zero therefore must be encoded as "0".

<coordinate data> = [(-|+)]<digit>{<digit>}

To interpret the coordinate string, it is first padded with leading zeros until the total number of digits is I+D; then the decimal point is placed at I integer and D decimal digits. For example, the format 26 specifies 2 integer and 6 decimal digits. The coordinate string "01500" is padded in front to reach $2+6 = 8$ digits, or "00001500"; the decimal point is placed to have 2 integer and 6 decimal digits, or "00.001500"; the coordinate "015" therefore represents the decimal number 0.0015.

3.6.4 Hexadecimal

A hexadecimal value is a sequence of characters that matches the regular expression:

$[a-fA-F0-9]^+$

The letters in a hexadecimal value can be upper case or lower-case characters; 'A9' and 'a9' represent the same value.

3.6.5 Names

Names consist of upper- or lower-case letters, underscores ('_'), dots ('.'), a dollar sign ('\$') and digits. The first character *cannot* be a digit.

Name = $[a-zA-Z_.\$]\{[a-zA-Z_0-9]^+\}$

Names can be maximally 127 characters long.

Names are case-sensitive: Name \neq name

Names beginning with a dot '.' are reserved for *standard names* defined in the specification. User defined names *cannot* begin with a dot.

The scope of a name starts at its definition and runs till the end of the file.

Note: The variable names within macro's follow their own rules.

3.6.6 Strings

Strings are made up of all valid characters except the reserved characters CR, LF, '%' and '*'.

```
String = [a-zA-Z0-9_+~!/?<>"'(){}.\|&@# , ; $ :=]+
```

Strings can be maximally 65,535 characters long (65,535 fits in an unsigned int 16).

Strings are case-sensitive: `String` \neq `string`

Any character with a Unicode code lower than 65,536 can be included in a string by specifying the Unicode character code in hexadecimal in the Unicode escape sequence:

```
\uXXXX
```

The four characters XXXX are a hexadecimal number (see 3.6.4) indicating the code of the Unicode character represented by the escape sequence. For example, `\u00a9` represents the copyright symbol.

Unicode escape sequence must be six characters long. It means there must be exactly four characters following `\u`. If the character code contains less hexadecimal digits, it must be padded with leading zeros.

A hexadecimal number syntax allows upper case and lower case letters so both `\u00A9` and `\u00a9` are allowed and represent the same character.

The Unicode escape sequence syntax conforms to the regular expression:

```
\\u[a-fA-F0-9]{4}
```

A literal backslash character `\` inside a string shall be represented using the backslash character code as `\u005c`, otherwise, if `\` character and 5 next characters conform to the regular expression `\\u[a-fA-F0-9]{4}`, the whole sequence will be interpreted as the Unicode escape sequence.

For the string length the Unicode escape sequence is counted as one character.



Note: The Unicode escape sequences can be used only inside strings.

3.6.7 Fields

The fields follow the string syntax in section 3.6.6 with the additional restriction that a field must not contain commas. Fields are intended to represent comma-separated items in strings. If a field must contain a comma it can be represented by the Unicode above.

4 Graphics

4.1 Format Specification (FS)

The FS (Format Specification) specifies the format of the coordinate data – see 3.6.3 - used in operation commands. (The MO command specifies the unit in which the coordinates are expressed, see 4.2.)

The FS command is mandatory. It must be used once and only once, in the header, before the first use of coordinate data. It is recommended to put it as the very first non-comment line.

The syntax for the FS command is:

<FS command> = FSLAX<Format>Y<Format>*
<Format> = <digit><digit>

Syntax	Comments
FS	FS for Format Specification
LA	These fixed characters are necessary for backwards compatibility. See 7.3 for more details.
X<Format>Y<Format>	Specifies the format of X and Y coordinate data. The format of X and Y coordinate must be the same; it is specified as X and Y separately for backwards compatibility.
<Format> = <digit><digit>	The first digit sets the number of integer digits in the coordinate data, the second the number of decimal digits. The number of integer digits can be is up to 6; use the smallest number that fits the size of the image; 2 or 3 integer digits is typical. The number of decimal digits must be 5 or 6.

 **Example:**

Syntax	Comments
%FSLAX26Y26*%	Coordinates have 2 integer and 6 decimal digits maximum.

The resolution of a Gerber file is the distance expressed by the least significant digit of coordinate data. *The resolution of a Gerber file must be at least 0.001 mil or 25 nm.* When the unit is inch, the number of decimals must be set at 6; the resolution is then 0.001 mil or 25 nm. When the unit is mm, the number of decimals must be at least 5, with a resolution of 10 nm, or 6, with a resolution of 1 nm.

4.2 Unit (MO)

The MO (Mode) command sets the units used for coordinates and for parameters or modifiers indicating sizes or coordinates. The units can be either inches or millimeters. This command is mandatory. It must be used once and only once at the beginning of a file, before the first use of coordinate data. Normally MO command follows immediately after FS command (see 4.1).

The syntax for the MO command is:

<MO command> = MO(IN|MM)*

Syntax	Comments
MO	MO for Mode
IN MM	Units of the dimension data: IN – inches MM – millimeters

Examples:

Syntax	Comments
%MOIN*%	Dimensions are expressed in inches
%MOMM*%	Dimensions are expressed in millimeters



Note: Always use mm, the metric unit, with 6 decimals. This expresses any imperial value with a resolution of 1/100 of a mil or larger without any rounding – amply sufficient for PCBs. An application may need to display imperial units, but that does not require the underlying file to be imperial. Inch is only there for historic reasons and is now a useless embellishment.

4.3 Aperture Definition (AD)

4.3.1 AD Command

The AD command creates an aperture and adds it to the apertures dictionary. It starts with 'AD' letters, followed by

- 'D' letter and D-code number (or aperture number)
- the aperture template name
- optional modifiers

The D-code identifies the aperture. The Dnn command uses the D-code to select it as the current aperture (see 4.7).

The AD command must precede the first use of the D-code. It is recommended to put all AD commands in the file header.

The allowed range of D-code is from 10 up to 2.147.483.647 (max int 32). The D-codes 0 to 9 are reserved and *cannot* be used for apertures. Once a D-code number is assigned it *cannot* be re-assigned – thus apertures are uniquely identified by their D-code.

The syntax for the AD command is as follows:

<AD command> = ADD<D-code number><Template>[,<Modifiers set>]*

<Modifiers set> = <Modifier>{X<Modifier>}

Syntax	Comments
ADD	'AD' is the command code and 'D' for D-code
<D-code number>	The D-code number being defined (≥10)
<Template>[,<Modifiers set>]	The template name, optionally followed by modifiers

The template name refers to the template selected from the aperture templates dictionary (see 2.2). The required modifiers in <Modifiers set> are specific to the template used. Modifiers are separated by the upper case 'X' character. All sizes are decimal numbers, units follow the MO command.



Example:

```
%ADD10C, .025*%
```

```
%ADD10C, 0.5X0.25*%
```

4.3.2 Zero-size Apertures

As a general rule, apertures with size zero are not valid, and so are objects created with them.

There is one exception. The C (circular) standard aperture with zero diameter is allowed, and so are objects created with it. Attributes can be attached to them. For the avoidance of doubt, it is the C aperture only where zero-size that can be valid, not another aperture whose shape fortuitously happens to be circular.

Zero-size objects do not affect the image. They can be used to provide meta-information to locations in the image plane.

Allowed does *not* mean recommended, quite the contrary. If you are tempted to use a zero-size circle, consider whether it is useful, or if there is no proper way to convey the intended information. The goal is not to have zero-size apertures. (Of course, do not simply replace zero-size by a positive size when there is no object just to avoid zero size; this would falsify the image.)

Do not abuse a zero-object to indicate the *absence* of an object, e.g. by flashing a zero-size aperture to indicate the absence of a flash. Needless zero-objects are just confusing as they direct the reader to look for meta-information that is not there. If there is nothing, put nothing.

4.3.3 Examples

Syntax	Comments
<code>%ADD10C, .025*%</code>	Create aperture with D-code 10: a solid circle with diameter 0.025
<code>%ADD22R, .050X.050X.027*%</code>	Create aperture with D-code 22: a rectangle with sides of 0.05 – therefore forming a square - and with a 0.027 diameter round hole
<code>%ADD57O, .030X.040X.015*%</code>	Create aperture with D-code 57: an obround with sizes 0.03 x 0.04 with 0.015 diameter round hole
<code>%ADD30P, .016X6*%</code>	Create aperture with D-code 30: a solid polygon with 0.016 outer diameter and 6 vertices
<code>%ADD15CIRC*%</code>	Create aperture with D-code 15: instantiate a macro aperture described by aperture macro CIRC defined previously by an aperture macro (AM) command

4.4 Standard Aperture Templates

4.4.1 Overview

Standard Aperture Templates			
Name	Shape	Modifiers	Section
C	Circle	Diameter, Hole diameter	4.4.2
R	Rectangle	X size, Y size, Hole diameter	4.4.3
O	Obround	X size, Y size, Hole diameter	4.4.4
P	Polygon	Outer diameter, # vertices, Rotation, Hole diameter	4.4.5

Table with standard aperture templates

4.4.2 Circle

The syntax of the circle standard aperture template:

C,<Diameter>[X<Hole diameter>]

Syntax	Comments
C	Indicates the circle aperture template.
<Diameter>	Diameter. A decimal ≥ 0 .
<Hole diameter>	Diameter of a round hole. A decimal > 0 . If omitted the aperture is solid. See also section 4.4.6.



Examples:

```
%ADD10C,0.5*%
```

```
%ADD10C,0.5X0.25*%
```

These commands define the following apertures:

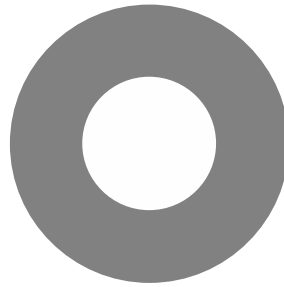
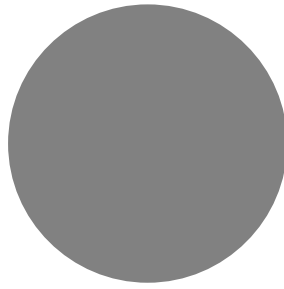

8. Circles

4.4.3 Rectangle

The syntax of the rectangle or square standard aperture template:

R,<X size>X<Y size>[X<Hole diameter>]

Syntax	Comments
R	Indicates the rectangle aperture template.
<X size> <Y size>	X and Y sizes of the rectangle. Decimals >0. If <X size> = <Y size> the effective shape is a square.
<Hole diameter>	Diameter of a round hole. A decimal >0. If omitted the aperture is solid. See also section 4.4.6.



Examples:

`%ADD22R,0.044X0.025*%`

`%ADD23R,0.044X0.025X0.019*%`

These commands define the following apertures:

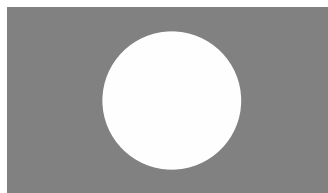

9. Rectangles

4.4.4 Obround

Obround (oval) is a shape consisting of two semicircles connected by parallel lines tangent to their endpoints. It can be viewed as a rectangle where the smallest side is rounded to a half-circle. The syntax of the obround standard aperture template:

O,<X size>X<Y size>[X<Hole diameter>]

Syntax	Comments
O	Indicates the obround aperture template.
<X size> <Y size>	X and Y sizes of enclosing box. Decimals >0. If <X size> = <Y size> the effective shape is a circle.
<Hole diameter>	Diameter of a round hole. A decimal >0. If omitted the aperture is solid. See also section 4.4.6.



Example:

```
%ADD220,0.046X0.026*%
```

```
%ADD220,0.046X0.026X0.019*%
```

These commands define the following apertures:

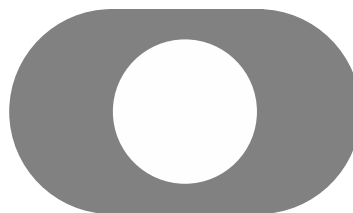

10. Obrounds

4.4.5 Polygon

Creates a *regular* polygon aperture. The syntax of the polygon standard aperture template:

P,<Outer diameter>X<Number of vertices>[X<Rotation>[X<Hole diameter>]]

Syntax	Comments
P	Indicates the polygon aperture template.
<Outer diameter>	Diameter of the circumscribed circle, i.e. the circle through the polygon vertices. A decimal > 0.
<Number of vertices>	Number of vertices n, $3 \leq n \leq 12$. An integer.
<Rotation angle>	The rotation angle, in degrees counterclockwise. A decimal. With rotation angle zero there is a vertex on the positive X-axis through the aperture center.
<Hole diameter>	Diameter of a round hole. A decimal >0. If omitted the aperture is solid. See also section 4.4.6.



Examples:

`%ADD17P, .040X6*%`

`%ADD17P, .040X6X0.0X0.019*%`

These commands define the following apertures:

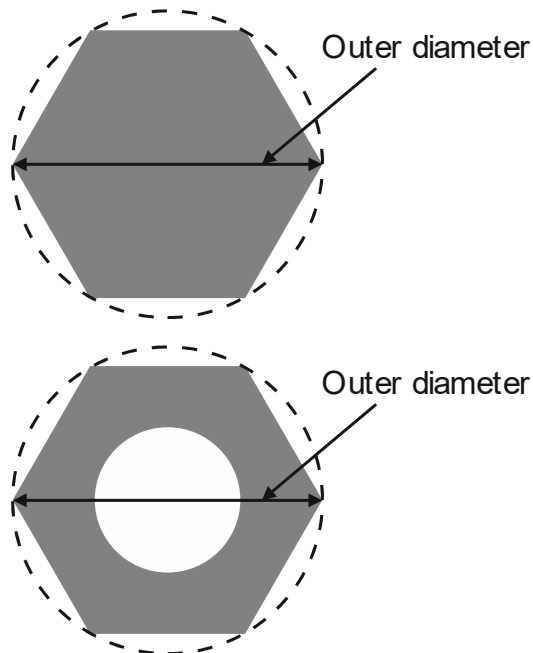

11. Polygons

4.4.6 Transparency of Holes

Standard apertures may have a round hole in them. When an aperture is flashed only the solid part affects the image, the hole does *not*. Objects under a hole remain visible through the hole. For image generation the area of the hole behaves exactly as the area outside the aperture. The hole is not part of the aperture.

 **Warning:** Make no mistake: holes do *not* clear the objects under them.

For all standard apertures the round hole is defined by specifying its diameter as the last modifier: <Hole diameter>. If <Hole diameter> is omitted the aperture is solid. If present the diameter must be ≥ 0 . The hole must strictly fit within the standard aperture. It is centered on the aperture.



Example:

```
%FSLAX26Y26*%  
%MOIN*%  
%ADD10C,10X5*%  
%ADD11C,1*%  
G01*  
%LPD*%  
D11*  
X-10000000Y-2500000D02*  
X10000000Y2500000D01*  
D10*  
X0Y0D03*  
M02*
```



12. Standard (circle) aperture with a hole above a draw

Note that the draw is visible through the hole.

4.5 Aperture Macro (AM)

The AM command creates a macro aperture template and adds it to the aperture template dictionary (see 2.2). A template is a parametrized shape. The AD command instantiates a template into an aperture by supplying values to the template parameters.

Templates of any shape or parametrization can be created. Multiple simple shapes called primitives can be combined in a single template. An aperture macro can contain variables whose actual values are defined by:

- Values provided by an AD command referencing the template
- Arithmetic expressions with other variables

The template is created by positioning primitives in a coordinate space. The origin of that coordinate space will be the origin of all apertures created with the state.

A template must be defined before the first AD that refers to it. The AM command can be used multiple times in a file.

4.5.1 AM Command

The syntax for the AM command is:

<AM command> = AM<Aperture macro name>*<Macro content>
<Macro content> = {{<Variable definition>*<Primitive>}}
<Variable definition> = \$K=<Arithmetic expression>
<Primitive> = <Primitive code>,<Modifier>{,<Modifier>}<Comment>
<Modifier> = \$M|< Arithmetic expression>
<Comment> = 0 <Text>

Syntax	Comments
AM	AM for Aperture Macro
<Aperture macro name>	Name of the aperture macro. The name must be unique, i.e. a name once given cannot be reused for another macro. See 3.6.5 for the syntax rules.
<Macro content>	Macro content describes primitives included into the aperture macro. Can also contain definitions of new variables.
<Variable definition>	Definition of a variable.
\$K=<Arithmetic expression>	Definition of the variable \$K. (K is an integer >0.) An arithmetic expression may use arithmetic operators described later, constants and variables \$X where the definition of \$X precedes \$K.
<Primitive>	A primitive is a basic shape to create the macro. It includes primitive code identifying the primitive and primitive-specific modifiers (e.g. center of a circle). All primitives are described in 4.5.4. The primitives are positioned in a coordinates system whose origin is the origin of the resulting apertures.

Syntax	Comments
<Primitive code>	A code specifying the primitive (e.g. polygon).
<Modifier>	Modifier can be a decimal number (e.g. 0.050), a variable (e.g. \$1) or an arithmetic expression based on numbers and variables. The actual value for a variable is either provided by an AD command or defined within the AM by some previous <Variable definition>.
<Comment>	Comment does not affect the image.
<Text>	Single-line text string



Note: Each AM command must be enclosed in a pair of ‘%’ characters (see 3.5.3).
Coordinates and sizes are expressed by a decimal number in the unit set by the MO command.

4.5.2 Exposure Modifier

The exposure modifier that can take two values:

- 0 means exposure is 'off'
- 1 means exposure is 'on'

Primitives with exposure 'on' create the solid part of the macro aperture. Primitives with exposure 'off' erase the solid part created earlier *in the same macro*. Exposure off is used to create a hole in the aperture – see also 4.4.6.

The erasing action of exposure off only acts on other primitives within the same macro definition. When a macro is flashed the hole does not clear objects in the final image – the hole is transparent. Another way of expressing it is that the macro definition is flattened before it is used, and the result is a positive image.

Warning: When the macro aperture is flashed, the erased area does *not* clear the underlying graphics objects. Objects under removed parts remain visible.



Example:

```
%FSLAX26Y26*%
%MOIN*%
%AMSquareWithHole*
21,1,10,10,0,0,0*
1,0,5,0,0*%
%ADD10SquareWithHole*%
%ADD11C,1*%
G01*
%LPD*%
D11*
X-10000000Y-2500000D02*
X10000000Y2500000D01*
D10*
X0Y0D03*
M02*
```



13. Macro aperture with a hole above a draw

Note that the draw is still visible through the hole.

4.5.3 Rotation Modifier

All primitives can be rotated around the *origin* of the macro definition, i.e. its point (0, 0). (Make no mistake: rotation is *not* around the geometric center of the primitive, unless of course it coincides with the origin.)

A rotation angle is expressed by a decimal number, in degrees counterclockwise. A positive angle means counterclockwise rotation, a negative angle clockwise. The rotation angle is defined by the rotation modifier, the last in the list of the primitive modifiers.

To rotate a macro composed of several primitives it is sufficient to rotate all primitives by the same angle. See illustration below.

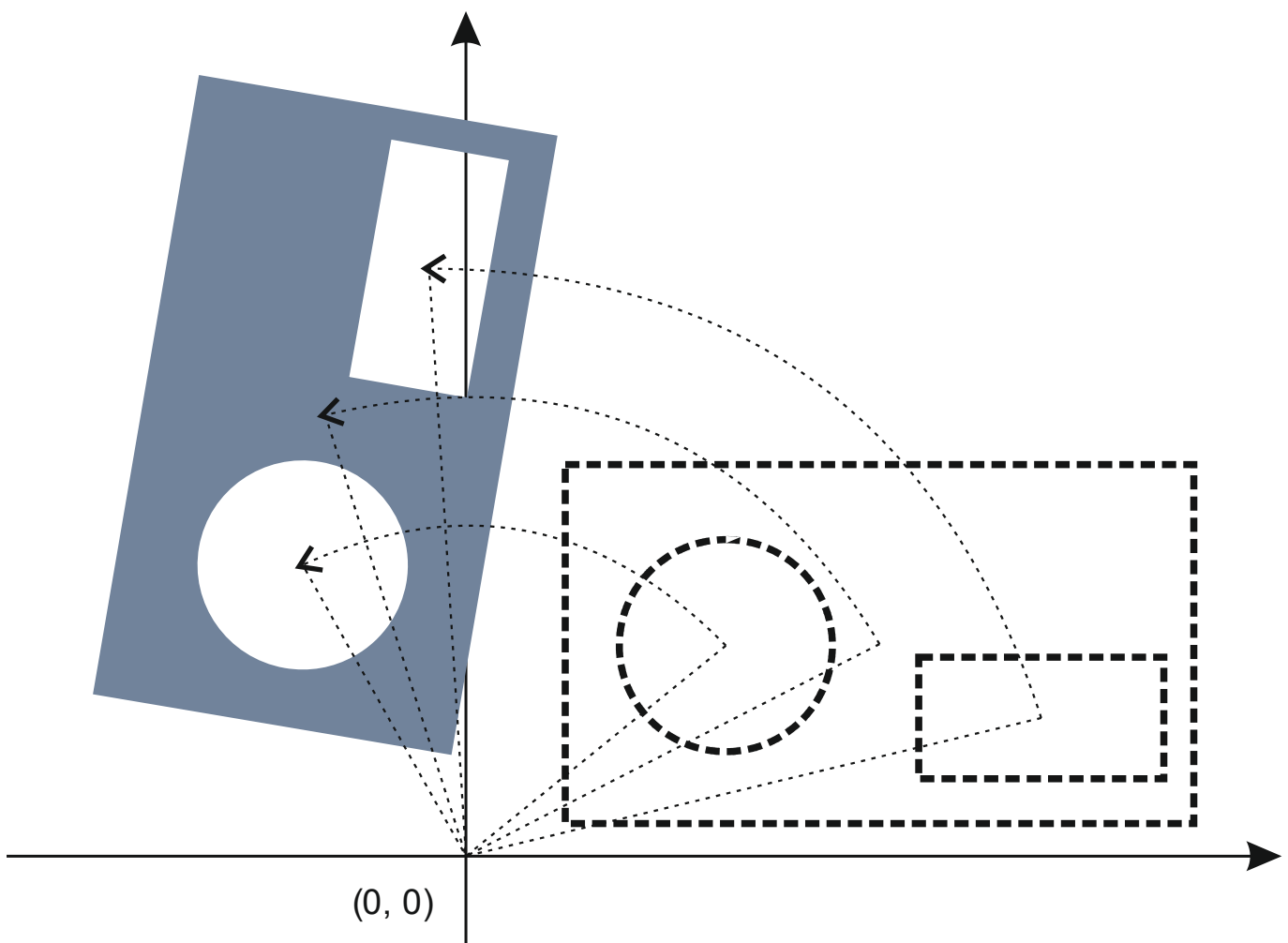

14. Rotation of an aperture macro composed of several primitives

Warning: Rotation is around the origin of the macro definition, not around the geometric center of the primitive – unless the two coincide of course. The reason is obvious: if rotation were about the center of each primitive a composite aperture like the one above would fall apart under rotation.

4.5.4 Primitives

4.5.4.1 Overview

Macro Primitives			
Code	Name	Modifiers	Section
0	Comment		4.5.4.2
1	Circle	Exposure, Diameter, Center X, Center Y, Rotation	4.5.4.3
20	Vector Line	Exposure, Width, Start X, Start Y, End X, End Y, Rotation	4.5.4.4
21	Center Line	Exposure, Width, Hight, Center X, Center Y, Rotation	4.5.4.5
4	Outline	Exposure, # vertices, Start X, Start Y, Subsequent points..., Rotation	4.5.4.6
5	Polygon	Exposure, # vertices, Center X, Center Y, Diameter, Rotation	4.5.4.7
6	Moiré	Center X, Center Y, Outer diameter rings, Ring thickness, Gap, Max # rings, Crosshair thickness, Crosshair length, Rotation	4.5.4.8
7	Thermal	Center X, Center Y, Outer diameter, Inner diameter, Gap, Rotation	4.5.4.9

Table with macro primitives

4.5.4.2 Comment, Code 0

The comment primitive has no effect on the image but adds human-readable comments in an AM command. The comment primitive starts with the '0' code followed by a space and then a single-line text string. The text string follows the syntax for strings in section 3.6.6.



Example:

```
%AMBox*
0 Rectangle with rounded corners, with rotation*
0 The origin of the aperture is it's center*
0 $1 X-size*
0 $2 Y-size*
0 $3 Rounding radius*
0 $4 Rotation angle, in degrees counterclockwise*
0 Add two overlapping rectangle primitives as box body*
21,1,$1,$2-$3-$3,0,0,$4*
21,1,$2-$3-$3,$2,0,0,$4*
0 Add four circle primitives for the rounded corners*
$5=$1/2*
$6=$2/2*
$7=2X$3*
1,1,$7,$5-$3,$6-$3,$4*
1,1,$7,-$5+$3,$6-$3,$4*
1,1,$7,-$5+$3,-$6+$3,$4*
1,1,$7,$5-$3,-$6+$3,$4*%
```

4.5.4.3 Circle, Code 1

A circle primitive is defined by its center point and diameter.

Modifier number	Description
1	Exposure off/on (0/1)
2	Diameter. A decimal ≥ 0
3	Center X coordinate. A decimal.
4	Center Y coordinate. A decimal.
5	Rotation angle of the center, in degrees counterclockwise. A decimal. The primitive is rotated around the origin of the macro definition, i.e. the (0, 0) point of macro coordinates. The rotation modifier is optional. The default is no rotation.

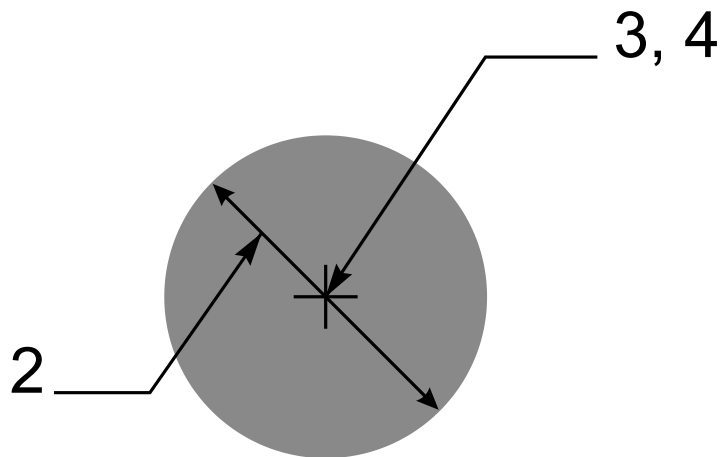

15. Circle primitive

Below there is the example of the AM command that uses the circle primitive.



Example:

```
%AMCIRCLE*  
1, 1, 1.5, 0, 0, 0*%
```

4.5.4.4 Vector Line, Code 20.

A vector line is a rectangle defined by its line width, start and end points. The line ends are rectangular.

Modifier number	Description
1	Exposure off/on. (0/1)
2	Width of the line. A decimal ≥ 0 .
3	Start point X coordinate. A decimal.
4	Start point Y coordinate. A decimal.
5	End point X coordinate. A decimal.
6	End point Y coordinate. A decimal.
7	Rotation angle, in degrees counterclockwise. A decimal. The primitive is rotated around the origin of the macro definition, i.e. the (0, 0) point of macro coordinates

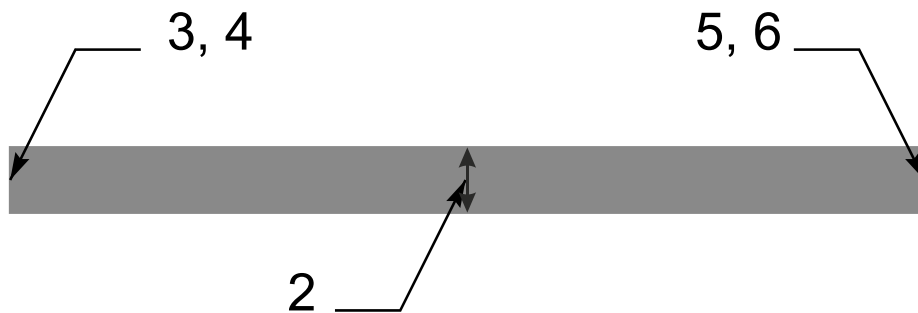

16. Vector line primitive

Below there is the example of the AM command that uses the vector line primitive.



Example:

```
%AMLIN*
```

```
20,1,0.9,0,0.45,12,0.45,0*%
```

4.5.4.5 Center Line, Code 21

A center line primitive is a rectangle defined by its width, height, and center point.

Modifier number	Description
1	Exposure off/on. (0/1)
2	Width. A decimal ≥ 0 .
3	Height. A decimal ≥ 0 .
4	Center point X coordinate. A decimal.
5	Center point Y coordinate. A decimal.
6	Rotation angle, in degrees counterclockwise. A decimal. The primitive is rotated around the origin of the macro definition, i.e. (0, 0) point of macro coordinates. ⚠ Warning: The rotation is <i>not</i> around the center point. (Unless the center point happens to be the macro origin.)

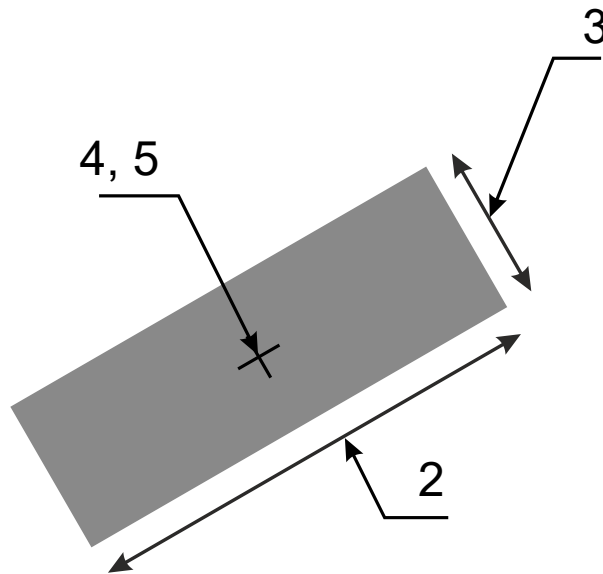

17. Center line primitive

Below there is the example of the AM command that uses the center line primitive.



Example:

```
%AMRECTANGLE*
21,1,6.8,1.2,3.4,0.6,30*%
```

4.5.4.6 Outline, Code 4

An outline primitive is an area defined by its outline or contour. The outline is a polygon, consisting of linear segments only, defined by its start vertex and n subsequent vertices. The outline must be closed, i.e. the last vertex must be equal to the start vertex. The outline must comply with all the requirements of a contour according to 4.12.3.

Modifier number	Description
1	Exposure off/on (0/1)
2	The number of vertices of the outline = the number of coordinate pairs <i>minus one</i> . An integer ≥ 3 .
3, 4	Start point X and Y coordinates. Decimals.
5, 6	First subsequent X and Y coordinates. Decimals.
...	Further subsequent X and Y coordinates. Decimals. The X and Y coordinates are <i>not</i> modal: both X <i>and</i> Y must be specified for all points.
3+2n, 4+2n	Last subsequent X and Y coordinates. Decimals. <i>Must</i> be equal to the start coordinates.
5+2n	Rotation angle, in degrees counterclockwise, a decimal. The primitive is rotated around the origin of the macro definition, i.e. the (0, 0) point of macro coordinates.

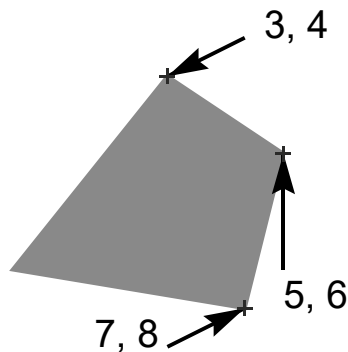

18. Outline primitive

The maximum number of vertices is 5000. The purpose of this primitive is to create apertures to flash *pads* with special shapes. The purpose is not to create copper pours. Use the region statement for copper pours; see 4.12.

 **Example:**

The following AM command defines an aperture macro named 'Triangle_30'. The macro is a triangle rotated 30 degrees around the origin of the macro definition:

```
%AMTRIANGLE_30*
4,1,3,
1,-1,
1,1,
2,1,
1,-1,
30*%
```

Syntax	Comments
AM Triangle_30	Aperture macro name is 'Triangle_30'
4,1,3	4 – Outline 1 – Exposure on 3 – The outline has three subsequent points
1,-1	1 – X coordinate of the start point -1 – Y coordinate of the start point
1,1, 2,1, 1,-1,	Coordinates (X, Y) of the subsequent points: (1,1), (2,1), (1,-1). Note that the last point is the same as the start point
30	Rotation angle is 30 degrees counterclockwise

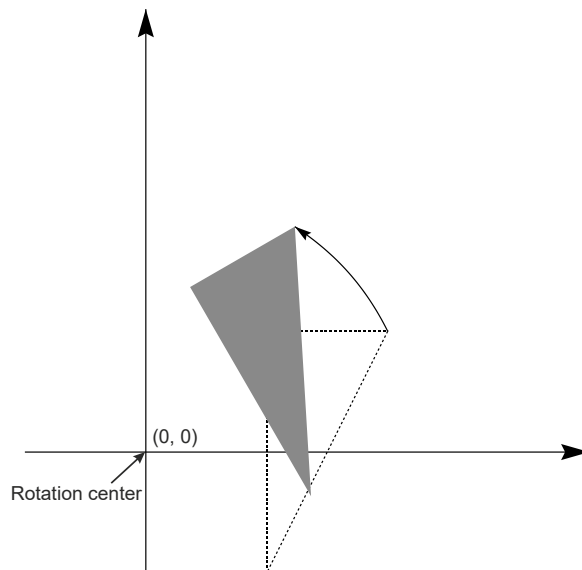

19. Rotated triangle

4.5.4.7 Polygon, Code 5

A polygon primitive is a regular polygon defined by the number of vertices n , the center point and the diameter of the circumscribed circle.

Modifier number	Description
1	Exposure off/on (0/1)
2	Number of vertices n , $3 \leq n \leq 12$. An integer. The first vertex is on the positive X-axis through the center point when the rotation angle is zero.
3	Center point X coordinate. A decimal.
4	Center point Y coordinate. A decimal.
5	Diameter of the circumscribed circle. A decimal ≥ 0 .
6	Rotation angle, in degrees counterclockwise. A decimal. With rotation angle zero there is a vertex on the positive X-axis through the aperture center. The primitive is rotated around the origin of the macro definition, i.e. the (0, 0) point of macro coordinates.

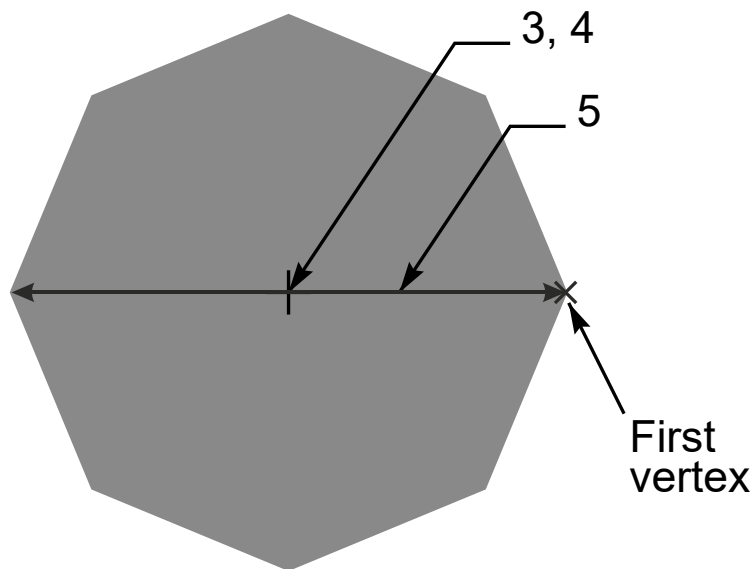

20. Polygon primitive



Example:

```
%AMPOLYGON*
5,1,8,0,0,8,0*%
```

4.5.4.8 Moiré, Code 6

The moiré primitive is a cross hair centered on concentric rings. Exposure is always on.

Modifier number	Description
1	Center point X coordinate. A decimal.
2	Center point Y coordinate. A decimal.
3	Outer diameter of outer concentric ring. A decimal ≥ 0 .
4	Ring thickness. A decimal ≥ 0 .
5	Gap between rings. A decimal ≥ 0 .
6	Maximum number of rings. An integer ≥ 0 . The effective number of rings can be less if the center is reached. If there is not enough space for the inner ring it becomes a full disc.
7	Crosshair thickness. A decimal ≥ 0 . If the thickness is 0 there are no crosshairs.
8	Crosshair length. A decimal ≥ 0 . If the length is 0 there are no crosshairs.
9	Rotation angle, in degrees counterclockwise. A decimal. The primitive is rotated around the origin of the macro definition, i.e. the (0, 0) point of macro coordinates.

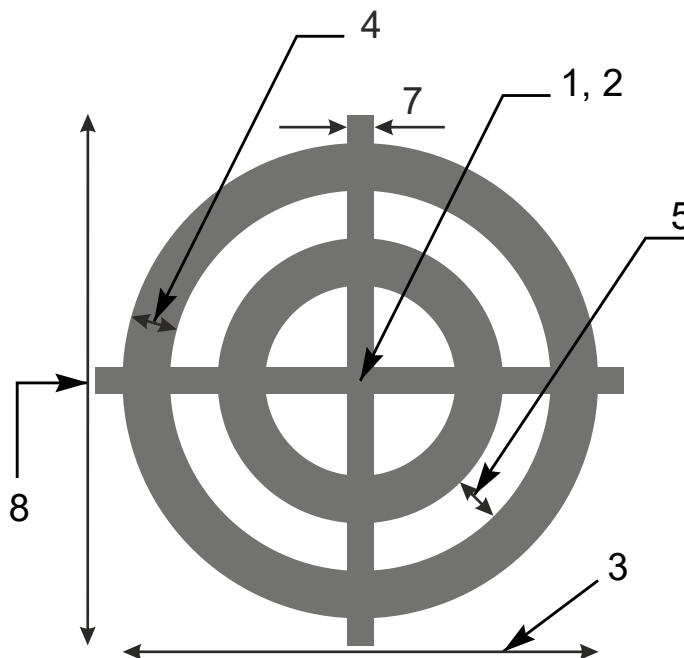

21. Moiré primitive

Below there is an example of a AM command that uses the moiré primitive.



Example:

%AMMOIRE*

6,0,0,5,0.5,0.5,2,0.1,6,0*%

4.5.4.9 Thermal, Code 7

The thermal primitive is a ring (annulus) interrupted by four gaps. Exposure is always on.

Modifier number	Description
1	Center point X coordinate. A decimal.
2	Center point Y coordinate. A decimal.
3	Outer diameter. A decimal > inner diameter
4	Inner diameter. A decimal ≥ 0
5	Gap thickness. A decimal $< (\text{outer diameter})/\sqrt{2}$. The gaps are on the X and Y axes through the center without rotation. They rotate with the primitive. Note that if the $(\text{gap thickness}) * \sqrt{2} \geq (\text{inner diameter})$ the inner circle disappears. This is not invalid.
6	Rotation angle, in degrees counterclockwise. A decimal. The primitive is rotated around the origin of the macro definition, i.e. (0, 0) point of macro coordinates.

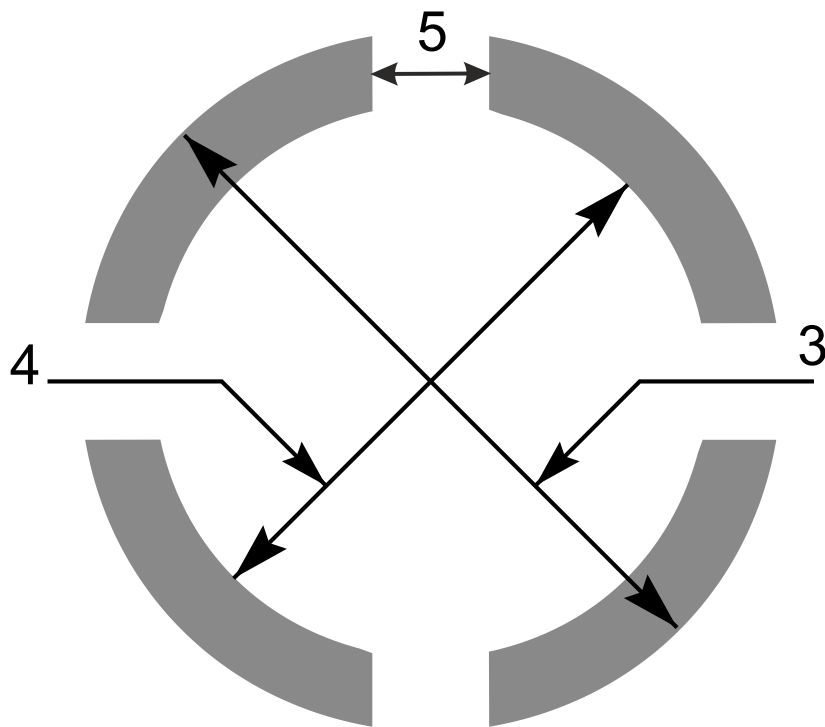

22. Thermal primitive

4.5.5 Syntax Details

An AM command contains the following data blocks:

- The AM declaration with the macro name
- Primitives with their comma-separated modifiers
- Macro variables, defined by an arithmetic expression

Each data block must end with the '*' character (see 3.4).

An aperture macro definition contains the macro name used to identify a template created by the macro. An AD command uses the macro name that is the name of the corresponding template in aperture templates dictionary.

An aperture macro definition also contains one or more aperture primitives described in 4.5.4. Each primitive, except the comment, is followed by modifiers setting its position, size, rotation etc. Primitive modifiers can use macro variables. The values for such variables is either provided by an AD command or calculated with arithmetic expression using other variables.

A modifier can be either:

- A decimal number, such as 0, 2, or 9.05
- A macro variable
- An arithmetic expression including numbers and variables

A macro variable name must be a '\$' character followed by an integer >0, for example \$12. (This is a subset of names allowed in 3.6.5.)

Each AM command must be enclosed into a separate pair of '%' characters. Line separators between data blocks of a single command can be added to enhance readability. These line separators do not affect the macro definition.

4.5.5.1 Variable Values from an AD Command

An AM command can use variables whose actual values are provided by an AD command that instantiates the template. Such variables are identified by '\$n' where n indicates the serial number of the variable value in the list provided by an AD command. Thus \$1 means the first value in the list, \$2 the second, and so on.



Example:

```
%AMDONUTVAR*1, 1, $1, $2, $3*1, 0, $4, $2, $3*%
```

Here the variables \$1, \$2, \$3 and \$4 are used as modifier values. The corresponding AD command should look like:

```
%ADD34DONUTVAR, 0.100X0X0X0.080*%
```

In this case the value of variable \$1 becomes 0.100, \$2 and \$3 become 0 and \$4 becomes 0.080. These values are used as the values of corresponding modifiers in the DONUTVAR macro.

4.5.5.2 Arithmetic Expressions

A modifier value can also be an arithmetic expression consisting of arithmetic operators, constants, with or without decimal point, and other variables. The standard arithmetic precedence rules apply. The brackets '(' and ')' are available to overrule the standard precedence.

The following arithmetic operators are available:

Operator	Function
+	Unary plus (expressions are positive even without the unary plus)
-	Unary minus (negates an expression)
+	Add
-	Subtract
x (lower case, preferred)	Multiply
X (upper case, <i>not</i> preferred)	Multiply
/	Divide. The result is a decimal; it is not rounded or truncated to an integer.

Arithmetic operators

Their precedence is as follows:

- '(' and ')'
- The unary '+', '-', 'x', 'X' and '/'
- '+' and '-'



Example:

```
%AMRect*
21, 1, $1, $2-$3-$3, -$4, -$5, 0*%
```

The corresponding AD command could look like:

```
%ADD146Rect, 0.0807087X0.1023622X0.0118110X0.5000000X0.3000000*%
```

4.5.5.3 Definition of a New Variable

The AM command allows defining new macro variables based on previously defined variables. A new variable is defined as an arithmetic expression that follows the same rules as described in previous section. A variable definition also includes '=' sign with the meaning 'assign'.

For example, to define variable \$4 as a variable \$1 multiplied by 1.25 the following arithmetic expression can be used: \$4=\$1x1.25



Example:

```
%AMDONUTCAL*
1, 1, $1, $2, $3*
$4=$1x1.25*
1, 0, $4, $2, $3*%
```

The values for variables in an AM command are determined as follows:

- All variables used in AM command are initialized to 0

- If an AD command that references the aperture macro contains n modifiers then variables \$1,\$2, ..., \$n get the values of these modifiers
- The remaining variables get their values from definitions in the AM command; if some variable remains undefined then its value is still 0
- The values of variables \$1, \$2, ..., \$n can also be modified by definitions in AM, i.e. the values originating from an AD command can be redefined



Example:

```
%AMDONUTCAL*
1, 1, $1, $2, $3*
$4=$1x0.75*
1, 0, $4, $2, $3*%
```

The variables \$1, \$2, \$3, \$4 are initially set to 0.

If the corresponding AD command contains only 2 modifiers then the value of \$3 will remain 0.

If the corresponding AD command contains 4 modifiers. e.g.

```
%ADD35DONUTCAL, 0.020X0X0X0.03*%
```

the variable values are calculated as follows: the AD command modifier values are first assigned so variable values \$1 = 0.02, \$2 = 0, \$3 = 0, \$4 = 0.03. The value of \$4 is modified by definition in AM command so it becomes \$4 = 0.02 x 0.75 = 0.015.

The variable definitions and primitives are handled from the left to the right in the order of AM command. This means a variable can be set to a value, used in a primitive, re-set to a new value, used in a next primitive etc.



Example:

```
%AMTARGET*
1, 1, $1, 0, 0*
$1=$1x0.8*
1, 0, $1, 0, 0*
$1=$1x0.8*
1, 1, $1, 0, 0*
$1=$1x0.8*
1, 0, $1, 0, 0*
$1=$1x0.8*
1, 1, $1, 0, 0*
$1=$1x0.8*
1, 0, $1, 0, 0*
$1=$1x0.8*
1, 0, $1, 0, 0*
%ADD37TARGET, 0.020*%
```



Here the value of \$1 is changed by the expression '\$1=\$1x0.8' after each primitive so the value changes like the following: 0.020, 0.016, 0.0128, 0.01024, 0.008192, 0.0065536.



Example:

```
%AMREC1*
$2=$1*
$1=$2*
21, 1, $1, $2, 0, 0, 0*%
%AMREC2*
$1=$2*
$2=$1*
21, 1, $1, $2, 0, 0, 0*%
%ADD51REC1, 0.02X0.01*%
%ADD52REC2, 0.02X0.01*%
```

Aperture 51 is the square with side 0.02 and aperture 52 is the square with side 0.01, because the variable values in AM commands are calculated as follows:

For the aperture 51 initially \$1 is 0.02 and \$2 is 0.01. After operation '\$2=\$1' the variable values become \$2 = 0.02 and \$1 = 0.02. After the next operation '\$1=\$2' they remain \$2 = 0.02 and \$1 = 0.02 because previous operation changed \$2 to 0.02. The resulting primitive has 0.02 width and height.

For the aperture 52 initially \$1 is 0.02 and \$2 is 0.01 (the same as for aperture 51). After operation '\$1=\$2' the variable values become \$1 = 0.01 and \$2 = 0.01. After the next operation '\$2=\$1' they remain \$1 = 0.01 and \$2 = 0.01 because previous operation changed \$1 to 0.01. The resulting primitive has 0.01 width and height.

Below are some more examples of using arithmetic expressions in AM command. Note that some of these examples probably do not represent a reasonable aperture macro – they just illustrate the syntax that can be used for defining new variables and modifier values.



Examples:

```
%AMTEST*
1, 1, $1, $2, $3*
$4=$1x0.75*
$5= ($2+100) x1.75*
1, 0, $4, $5, $3*%
```

```
%AMTEST*
$4=$1x0.75*
$5=100+$3*
1, 1, $1, $2, $3*
1, 0, $4, $2, $5*
$6=$4x0.5*
1, 0, $6, $2, $5*%
```

4.5.6 Examples

4.5.6.1 Fixed Modifier Values

The following AM command defines an aperture macro named 'DONUTFIX' consisting of two concentric circles with fixed diameter sizes:

```
%AMDONUTFIX*
1, 1, 0.100, 0, 0*
1, 0, 0.080, 0, 0*%
```

Syntax	Comments
AMDONUTFIX	Aperture macro name is 'DONUTFIX'
1,1,0.100,0,0	1 – Circle 1 – Exposure on 0.100 – Diameter 0 – X coordinate of the center 0 – Y coordinate of the center
1,0,0.080,0,0	1 – Circle 0 – Exposure off 0.080 – Diameter 0 – X coordinate of the center 0 – Y coordinate of the center

An example of an AD command using this aperture macro:

```
%ADD33DONUTFIX*%
```

4.5.6.2 Variable Modifier Values

The following AM command defines an aperture macro named 'DONUTVAR' consisting of two concentric circles with variable diameter sizes:

```
%AMDONUTVAR*
1, 1, $1, $2, $3*
1, 0, $4, $2, $3*%
```

Syntax	Comments
AMDONUTVAR	Aperture macro name is 'DONUTVAR'
1,1,\$1,\$2,\$3	1 – Circle 1 – Exposure on \$1 – Diameter is provided by AD command \$2 – X coordinate of the center is provided by AD command \$3 – Y coordinate of the center is provided by AD command
1,0,\$4,\$2,\$3	1 – Circle 0 – Exposure off \$4 – Diameter is provided by AD command \$2 – X coordinate of the center is provided by AD command (same as in first circle) \$3 – Y coordinate of the center is provided by AD command (same as in first circle)

The AD command using this aperture macro can look like the following:

```
%ADD34DONUTVAR, 0.100X0X0X0.080*%
```

In this case the variable modifiers get the following values: \$1 = 0.100, \$2 = 0, \$3 = 0, \$4 = 0.080.

4.5.6.3 Definition of a New Variable

The following AM command defines an aperture macro named 'DONUTCAL' consisting of two concentric circles with the diameter of the second circle defined as a function of the diameter of the first:

```
%AMDONUTCAL*  
1, 1, $1, $2, $3*  
$4=$1x0.75*  
1, 0, $4, $2, $3*%
```

Syntax	Comments
AMDONUTCAL	Aperture macro name is 'DONUTCAL'
1,1,\$1,\$2,\$3	1 – Circle 1 – Exposure on \$1 – Diameter is provided by AD command \$2 – X coordinate of the center is provided by AD command \$3 – Y coordinate of the center is provided by AD command
\$4=\$1x0.75	Defines variable \$4 to be used as the diameter of the inner circle; the diameter of this circle is 0.75 times the diameter of the outer circle

1,0,\$4,\$2,\$3	1 – Circle 0 – Exposure off \$4 – Diameter is calculated using the previous definition of this variable \$2 – X coordinate of the center is provided by AD command (same as in first circle) \$3 – Y coordinate of the center is provided by AD command (same as in first circle)
-----------------	---

The AD command using this aperture macro can look like the following:

```
%ADD35DONUTCAL, 0.020X0X0*%
```

This defines a donut with outer circle diameter equal to 0.02 and inner circle diameter equal to 0.015.

4.5.6.4 A useful macro

The following example creates a rectangle with rounded corners, useful as SMD pad.
It uses the following construction:

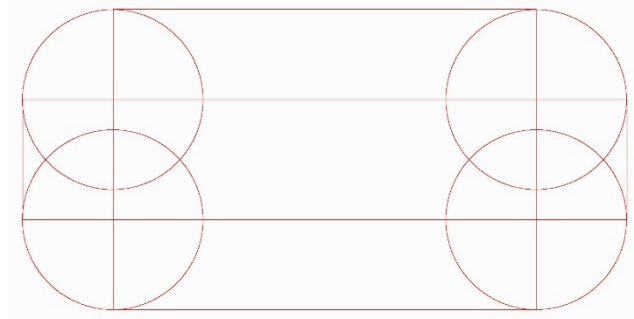

23. Construction of the Box macro

```
%AMBox*
0 Rectangle with rounded corners, with rotation*
0 The origin of the aperture is it's center*
0 $1 X-size*
0 $2 Y-size*
0 $3 Rounding radius*
0 $4 Rotation angle, in degrees counterclockwise*
0 Add two overlapping rectangle primitives as box body*
21,1,$1,$2-$3-$3,0,0,$4*
21,1,$2-$3-$3,$2,0,0,$4*
0 Add four circle primitives for the rounded corners*
$5=$1/2*
$6=$2/2*
$7=2X$3*
1,1,$7,$5-$3,$6-$3,$4*
1,1,$7,-$5+$3,$6-$3,$4*
1,1,$7,-$5+$3,-$6+$3,$4*
1,1,$7,$5-$3,-$6+$3,$4*%
```

4.6 Block Aperture (AB)

4.6.1 Overview of block apertures

The AB command creates a *block aperture*. The command stream between the opening and closing AB command defines a block aperture which is stored in the aperture dictionary. Thus the AB commands add an aperture to the dictionary directly, without needing an AD command. The LM, LR, LS and LP commands affect the flashes of block apertures in as any other aperture: when a block aperture is flashed, it is first transformed according to the transformation parameters in the graphics state and then added to the object stream.

The origin of the block aperture is the (0,0) point of the file.

A block aperture is not a single graphics object but a set of objects. While a standard or macro aperture always adds a single graphics object to the stream, a block aperture can add any number of objects, each with their own polarity. Standard and macro apertures always have a single polarity while block apertures can contain both dark and clear objects.

If the polarity is dark (LPD) when the block is flashed then the block aperture is inserted as is. If the polarity is clear (LPC) then the polarity of all objects in the block is toggled (clear becomes dark, and dark becomes clear). This toggle propagates through all nesting levels. In the following example the polarity of objects in the flash of block D12 will be toggled.

```
%ABD12*%
...
%AB*%
...
D12*
%LPC*%
X-2500000Y-1000000D03*
```

A D03 of a block aperture updates the current point but otherwise leaves the graphics state unmodified, as with any other aperture.

The AB command was introduced in revision 2016.12

4.6.2 AB Statement Syntax

The syntax for the AB command is:

<AB command> = AB[<block D-code>]*

Syntax	Comments
AB	AB for Aperture Block. Opens an AB statement.
<block D-code>	The D-code under which the block is stored in the aperture dictionary.

Examples:

Syntax	Comments
%ABD12*%	Opens the definition of aperture D12
%AB*%	Closes the current AB statement.

The section between the opening and closing AB commands can contain nested AB commands. The resulting apertures are stored in the library and are available subsequently until the end of the file, also outside the enclosing AB section.

Here is the Backus-Naur form definition of an AB statement. We use the following primitives:

<single command> = all commands except SR, AB, G36, G37 and M02

<region statement> see 4.12.

<any statement> = <region statement>|<AB statement>|<SR statement>

The AB statement is then:

<AB open> = %ABD<integer>*% (The integer must be ≥ 10.)

<AB close> = %AB*%

<AB statement> = <AB open>{<single command>|<any statement>}<AB close>

Consequently, an AB statement can contain embedded AB or SR statements. The scope of names defined by an AB statement is the whole file.

The current point is *undefined* after an AB statement.

4.6.3 Usage of Block Apertures

The main purpose of block apertures is to repeat a sub-image without the need to repeat all the generating commands. Block apertures can be repeated at *any* location and *individually* mirrored, rotated and scaled. Block apertures are more powerful than the SR command: the SR only allows repeats on a regular grid, without mirror, rotate or scale, and, crucially, without nesting. Blocks are typically used to create panels without duplicating the data.

The second purpose of block apertures is to complement macro apertures. A block aperture consisting of a single region creates a single object with one polarity— as with standard or macro apertures. Thus, single object apertures of any shape can easily be created. Such a block aperture can be used to define pads. Blocks are simpler to create than macros. However, macros can have parameters and blocks cannot. On the other hand, a macro outline primitive support only linear segments while the contours in blocks support both linear and circular segments.

Do not use blocks – or macros - when a standard aperture is available. Standard apertures are built-in and therefore are processed faster.

4.6.4 Example

A complete Gerber file with nested blocks

```
G04 Ucamco copyright*
%TF.GenerationSoftware,Ucamco,UcamX,2016.04-160425*%
%TF.CreationDate,2016-04-25T00:00;00+01:00*%
%TF.Part,Other,Testfile*%
%FSLAX46Y46*%
%MOMM*%
G04 Define standard apertures*
%ADD10C,7.500000*%
%ADD11C,15*%
%ADD12R,20X10*%
%ADD13R,10X20*%
G04 Define block aperture D100, consisting of two draws and a round dot*
%ABD100*%
D10*
X65532000Y17605375D02*
Y65865375D01*
X-3556000D01*
D11*
X-3556000Y17605375D03*
%AB*%
G04 Define block aperture D102, consisting of 2x3 flashes of D101 and 1
flash of D12*
%ABD102*%
G04 Define nested block aperture D101, consisting of 2x2 flashes of D100*
%ABD101*%
D100*
X0Y0D03*
X0Y700000000D03*
X100000000Y0D03*
X100000000Y700000000D03*
%AB*%
D101*
X0Y0D03*
X0Y160000000D03*
X0Y320000000D03*
X230000000Y0D03*
X230000000Y160000000D03*
X230000000Y320000000D03*
D12*
X19500000Y-10000000D03*
%AB*%
G04 Flash D13 twice outside of blocks*
D13*
X-30000000Y10000000D03*
```

X143000000Y-30000000D03*
G04 Flash block D102 3x2 times*
D102*
X0Y0D03*
X0Y520000000D03*
X500000000Y0D03*
X500000000Y520000000D03*
X1000000000Y0D03*
X1000000000Y520000000D03*
M02*

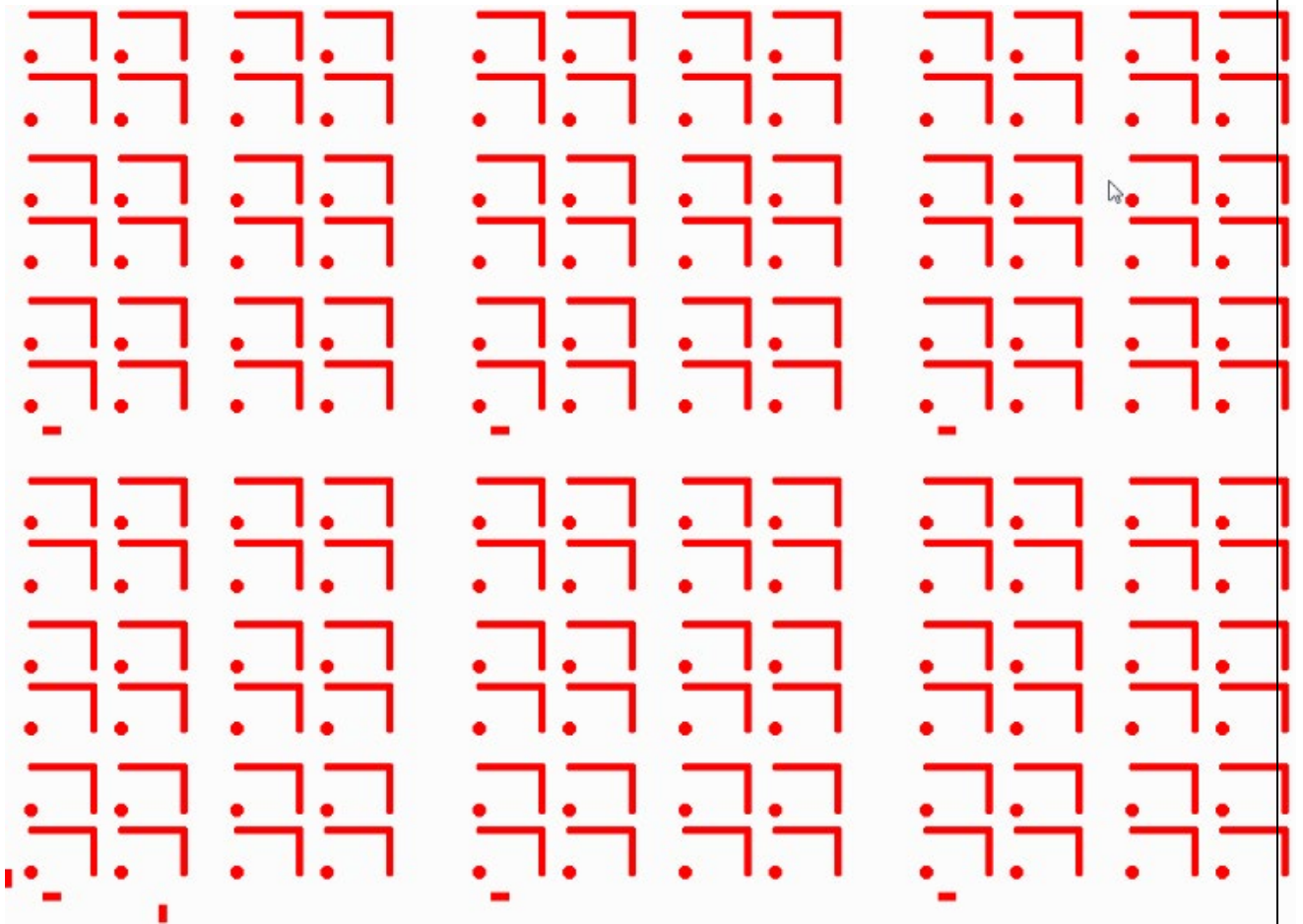

24. Block aperture example 1

4.7 Set Current Aperture (Dnn)

The command Dnn (nn≥10) sets the current aperture graphics state parameter.

The syntax is:

<Dnn command> = D<D-code number>*

Syntax	Comments
D	Command code
<D-code number>	The D-code number (≥10) of an aperture from the apertures dictionary The aperture must be previously added in the apertures dictionary by AD command

The allowed range of D-code is from 10 up to 2.147.483.647 (max int 32). The D-codes 0 to 9 are reserved and *cannot* be used for apertures.

The D01 and D03 commands use the current aperture to create track and flash graphics objects. The current aperture must be explicitly defined before it is used – see 2.5.



Example:

D10*

4.8 Operations (D01/D02/D03)

D01, D02 and D03 are the *operation codes*. Together with coordinate data the operation codes define commands called *operations*. An operation operates on its coordinate data.

Syntactically an operation contains the coordinate data followed by its operation code. An operation must contain a single (1) operation code: each operation code is associated with a single coordinate pair and vice versa.

The operations have the following effect.

- Operation with D01 code is called *interpolate* operation. It creates a straight-line segment or a circular segment by interpolating from the current point to the operation coordinates. The segment is then converted to a graphics object outside a region statement or to a contour segment inside.
- Operation with D02 code is called *move* operation. It moves the current point to the operation coordinates. No graphics object is generated.
- Operation with D03 code is called *flash* operation. It creates a flash object by replicating the current aperture at the operation coordinates.



Note: The code representation 01, 02, 03 (with one leading zero) is conventional; it is allowed to use a different number of leading zeros: 1, 001, 0002, etc. See 3.5.2 for more details.

The operations are controlled by the graphics state (see 2.5).

The D03 operation directly creates a flash object by replicating (flashing) the current aperture. When the aperture is flashed its origin is positioned at the coordinates of the operation. The origin of a standard aperture is its geometric center. The origin of a macro aperture is the origin of the coordinates (the origin of the macro definition) used in the AM (Aperture Macro) command.

Sequences of D01 and D02 operations create segments that are turned into a graphics objects by one of two following methods:

- **Stroking.** The segments are stroked with the current aperture, see 2.4.
- **Region building.** The segments form contour that defines a region, see 4.12.

Outside a region statement stroking is used to convert a segment into draw or arc graphics object. Inside a region statement a segment becomes the linear or circular contour segment.

There is another graphics state parameter called interpolation mode that affects operations. It defines the form of the interpolated segment: linear interpolation mode results in a draw or linear contour segment; circular interpolation mode results in an arc or circular contour segment. This is described in detail in the section 4.9.

The circular interpolation mode can be clockwise and counterclockwise. In circular interpolation mode the quadrant mode becomes relevant. See 4.10 for more details.

The table below summarizes the results of the operations depending on the graphics state parameter values.

Operation code	Graphics state parameters values					
	Inside a region statement (G36)			Outside a region statement (G37)		
	Linear interpolation mode (G01)	Circular interpolation mode (G02, G03)		Linear interpolation mode (G01)	Circular interpolation mode (G02, G03)	
		Single quadrant mode (G74)	Multi quadrant mode (G75)		Single quadrant mode (G74)	Multi quadrant mode (G75)
D01	Linear contour segment	Circular contour segment ($0^\circ \leq \alpha \leq 90^\circ$)	Circular contour segment ($0^\circ < \alpha \leq 360^\circ$)	Draw	Arc ($0^\circ \leq \alpha \leq 90^\circ$)	Arc ($0^\circ < \alpha \leq 360^\circ$)
	Moves current point				Moves current point	
D02	Closes current contour and moves current point			Moves current point only		
D03	Not allowed			Flash; moves current point		

Effect of operation codes depending on graphics state parameters

The table describes only the parameters which have direct influence on the types of objects created by the operation codes. The effect of the other parameters is described elsewhere.

4.8.1 Coordinates

The syntax of coordinates in the operations is as follows:

<Coordinates> = [X<Number>][Y<Number>][I<Number>][J<Number>]

Syntax	Comments
X, Y	Characters indicating X or Y coordinates of a point
I, J	Characters indicating a distance or offset in the X or Y direction. They are mandatory in D01 operations in circular interpolation mode (see 4.8.2) and only allowed there.
<Number>	Coordinate number - see section 3.6.3 - defining either a coordinate (X, Y) or an offset or distance (I, J). The number must have at least one digit

The FS and MO commands specify how to interpret the coordinate data. The coordinate data define points in the plane using a right-handed orthonormal coordinate system. The plane is infinite, but implementations can have size limitations.

Coordinates *are* modal. If an X is omitted, the X coordinate of the current point is used. Similar for Y. (This legacy compression technique has lost its usefulness.)

Offsets *are not* modal. If I or J is omitted, the default is zero (0). The offsets do not affect the current point.

Examples:

X200Y200D02*	point (+200, +200) operated upon by D02
Y-300D03*	point (+200, -300) operated upon by D03
I300J100D01*	point (+200, -300) and offset (+300, +100) operated upon by D01
Y200I50J50D01*	point (+200, +200) and offset (+50, +50) operated upon by D01
X200Y200I50J50D01*	point (+200, +200) and offset (+50, +50) operated upon by D01
X+100I-50D01*	point (+100, +200) and offset (-50, 0) operated upon by D01

In an operation without explicit X and Y the coordinates of the current point are used. In the example below D03 results in a flash at the current point.

 **Example**
D03*

4.8.2 D01 Command

The interpolation command defines a draw or arc graphics object, depending on the interpolation mode. See sections 4.9.2 and 4.10.4.

4.8.3 D02 Command

Performs a move operation, moving the current point to a new value. The syntax for the D02 code (move) operation is the following:

<D02 operation> = [X<Number>][Y<Number>]D02*

Syntax	Comments
X<Number>	<Number> is coordinate data – see section 3.6.3. It defines the X coordinate of the new current point. The default is the X coordinate of the old current point.
XY<Number>	<Number> is coordinate data – see section 3.6.3. It defines the Y coordinate of the new current point. The default is the Y coordinate of the old current point.
D02	Move operation code

The D02 command sets the new value for the current point. On top of that, inside a region statement it also closes the current contour. (see 4.12).

 **Example:**
X200Y1000D02*

4.8.4 D03 Command

Performs a flash operation, creating a flash graphics object. After the flash operation the current point is set to the origin of the flash

The syntax for the D03 code (flash) operation is the following:

<D03 operation> = [X<Number>][Y<Number>]D03*

Syntax	Comments
X<Number>	<Number> is coordinate data – see section 3.6.3. It defines the X coordinate of the aperture origin. The default is the X coordinate of the old current point.
Y<Number>	<Number> is coordinate data – see section 3.6.3. It defines the Y coordinate of the aperture origin. The default is the Y coordinate of the old current point.
D03	Flash operation code



Example:

X1000Y1000D03*

4.8.5 Example

The example shows a stream of commands in a Gerber file. Some of the commands are operation codes, others are G code commands (G01, G03, G36, G37, G74, and G75). The G code commands set the graphics state parameters that are relevant for the operations: interpolation mode (G01 – see 4.9, G03 – see 4.10), region statement (G36, G37 – see 4.12), quadrant mode (G74, G75 – see 4.10).



Example:

```
G36*
X200Y1000D02*
G01*
X1200D01*
Y200D01*
X200D01*
Y600D01*
X500D01*
G75*
G03*
X500Y600I300J0D01*
G01*
X200D01*
Y1000D01*
G37*
```

4.9 Linear Interpolation Mode (G01)

When linear interpolation mode is enabled a D01 code operation generates a straight line from the current point to the point with X, Y coordinates specified by the operation. The current point is then set to the X, Y coordinates.

The G01 command sets linear operation.

4.9.1 G01 Command

The syntax for the G01 command is as follows:

<G01 command> = G01*

Syntax	Comments
G01	Sets interpolation mode graphics state parameter to 'linear interpolation'



Example:

G01*

4.9.2 D01 Command

In G01 mode the interpolate command Dcreates a draw. After the D01 command the current point is moved to the end point of the draw. The D01 command syntax is:

<D01 operation> = [X<Number>][Y<Number>]D01*

Syntax	Comments
X<Number>	<Number> is coordinate data – see section 3.6.3. It defines the X coordinate of the straight segment. The default is the X coordinate of the old current point.
Y<Number>	<Number> is coordinate data – see section 3.6.3. It defines the Y coordinate of the straight segment. The default is the Y coordinate of the old current point.
D01	Interpolate operation code



Example:

G01*

X200Y200D01*

4.10 Circular Interpolation (G02/G03) and (G74/G75)

4.10.1 Circular Arc Overview

A circular arc is a circular segment created by a D01 (interpolate) operation when the graphics state set to circular interpolation, G02 or G03. Outside a region statement a track is added to the graphics object stream. Inside a region statement a contour segment is added to the current contour.

D01 code operation in circular interpolation mode generates a circular arc starting from the current point and with end point at the X, Y coordinates specified by the operation; the center of the arc is specified by the offsets I and J. The current point is then updated to the end point.

There are two orientations:

- Clockwise, set by G02 command
- Counterclockwise, set by G03 command

The orientation is defined around the center of the arc, moving from begin to end.

There are two quadrant modes:

- Single quadrant mode, set by G74 command
- Multi quadrant mode, set by G75 command

Quadrant mode	Comments
Single quadrant (G74)	<p>In single quadrant mode the arc is not allowed to extend over more than 90°. The following relation must hold:</p> $0^\circ \leq A \leq 90^\circ$, where A is the arc angle <p>If the start point of the arc is equal to the end point, the arc has length zero, i.e. it covers 0°. A separate operation is required for each quadrant. A minimum of four operations is required for a full circle.</p>
Multi quadrant (G75)	<p>In multi quadrant mode the arc is allowed to extend over more than 90°. To avoid ambiguity between 0° and 360° arcs the following relation must hold:</p> $0^\circ < A \leq 360^\circ$, where A is the arc angle <p>If the start point of the arc is equal to the end point, the arc is a full circle of 360°.</p>

Quadrant modes

The commands with codes G74 and G75 allow switching between single- and multi-quadrant modes. G75 command turns on multi quadrant mode. G74 command turns on single quadrant mode. The quadrant mode remains valid until changed by another G75 or G74.



Warning: A Gerber file that attempts to create an arc without a preceding G74 or G75 is invalid.

Mathematically, the distance from the center to the start point must be exactly equal to the distance to the end point. However, a Gerber file has a finite resolution. It is therefore generally not possible to position the center point exactly so that both distances – radii - are indeed exactly equal. Furthermore, the software generating the Gerber file unavoidably adds rounding

errors of its own. In real files the center is unavoidably not positioned exactly, and the two radii are not equal. We will call the difference between the start and end radius the *arc deviation*.

A mathematically exact circle has of course zero deviation. The interpretation of the arc command is then obvious. However, which curve is represented by a “circular arc” with a non-zero deviation? It cannot be a circular arc with the given center. Either it is not circular, it has another center, or it does not go from start to end. It is defined as follow.

Any continuous and monotonic curve starting at the start point and ending at the end point, approximating the ring with the given center point and with inner and outer radii equal to the start radius and end radius is a valid rendering of the arc command. See figure 25.

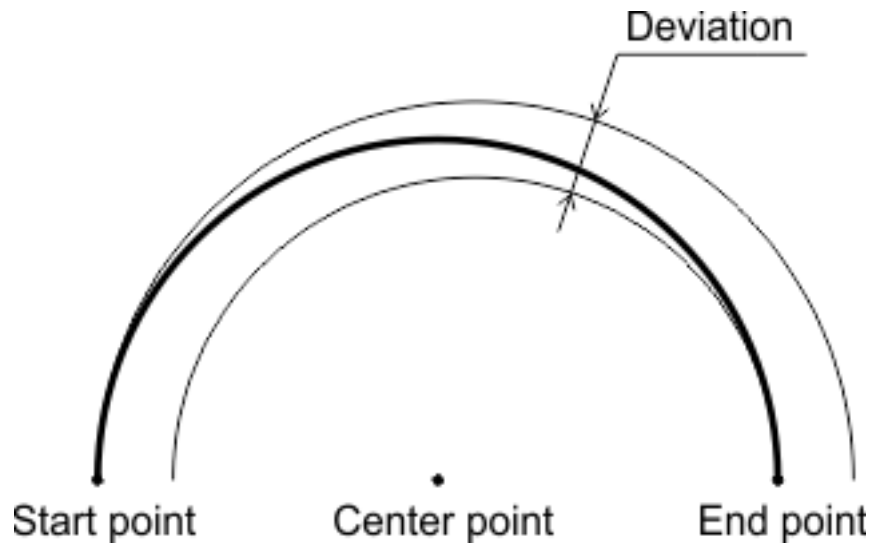

25. Arc with a non-zero deviation

The arc therefore has a fuzziness of the order of magnitude of the arc deviation. The writer of the Gerber file accepts any interpretation within the fuzziness above as valid. If the writer requires a more precise interpretation of the arc he needs to write more precise arcs, with lower deviation.

It is however not allowed to place the center point close to the straight line through begin and end point except when it is strictly in between these points. When the center is on or outside the segment between start and end point the construct is nonsensical. See figure 26.

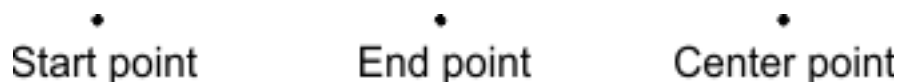

26. Nonsensical center point

Note that self-intersecting contours are not allowed, see 4.12.3. If any of the valid arc interpretations turns the contour in a self-intersecting one, the file is invalid, with unpredictable results.

The root cause of most problems with arcs is the use a low resolution. One sometimes attempts to force arcs of size of the order of e.g. 1/10 of a mil in a file with resolution of 1/10. This is asking for problems. Use higher resolution. See 4.16.

4.10.2 G02 & G03 Command

The G02 command sets clockwise circular interpolation mode, the G03 counterclockwise. The syntax is as follows:

<G02 command> = G02*

<G03 command> = G03*

Syntax	Comments
G02	Sets interpolation mode graphics state parameter to 'clockwise circular interpolation'
G03	Sets interpolation mode graphics state parameter to 'counterclockwise circular interpolation'



Examples:

G02*

4.10.3 G74 & G75 Command

The G74 command sets single quadrant mode, G75 multi-quadrant mode. The syntax is as follows:

<G74 command> = G74*

<G75 command> = G75*

Syntax	Comments
G74	Sets quadrant mode graphics state parameter to 'single quadrant'
G75	Sets quadrant mode graphics state parameter to 'multi quadrant'



Example:

G74*

4.10.4 D01 Command

In G02 or G03 mode the interpolate command D01 creates an arc. After the D01 command the current point is moved to the end point of the arc. The D01 command syntax is:

<D01 operation> = [X<Number>][Y<Number>][I<Number>][J<Number>]D01*

Syntax	Comments
X<Number>	<Number> is coordinate data – see section 3.6.3. It defines the X coordinate of the circular arc. The default is the X coordinate of the old current point.
Y<Number>	<Number> is coordinate data – see section 3.6.3. It defines the Y coordinate of the circular arc. The default is the Y coordinate of the old current point.
I<Number>	In single quadrant mode: the distance between the circular arc start point and the center measured parallel to the X axis. Number is ≥ 0 . In multi quadrant mode: the offset or signed distance between the circular arc start point and the center measured parallel to the X axis. The default is a 0 distance. <Number> is coordinate data – see section 3.6.3.
J<Number>	In single quadrant mode: the distance between the circular arc start point and the center measured parallel to the Y axis. Number is ≥ 0 . In multi quadrant mode: the offset or signed distance between the circular arc start point and the center measured parallel to the Y axis. The default is a 0 distance. <Number> is coordinate data – see section 3.6.3.
D01	Interpolate operation code

The coordinates of the endpoint, center distances and offsets are interpreted according to the coordinate format specified by the FS command and the unit specified by the MO command.

The following image illustrates how circular arcs are interpolated.

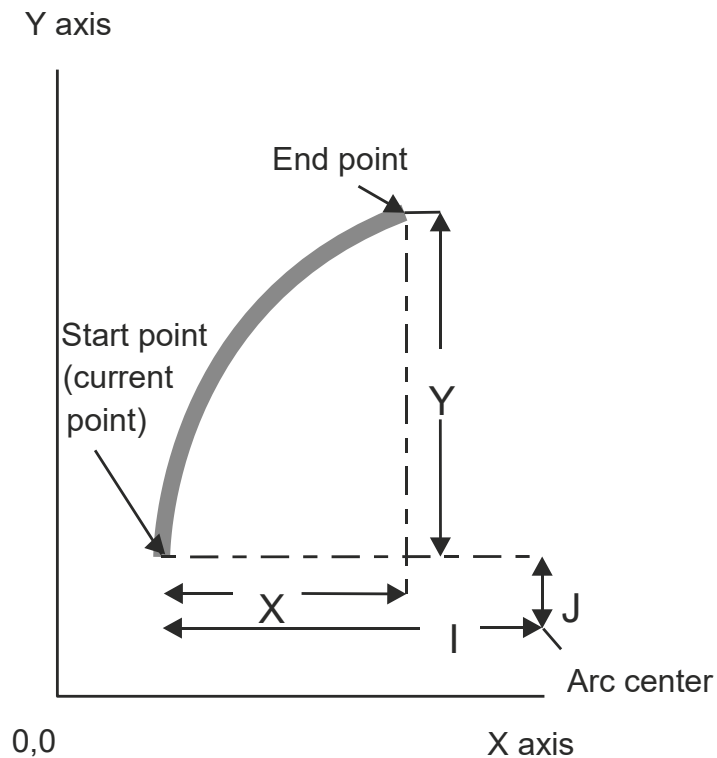

27. Circular interpolation example

In single quadrant mode, because the sign in offsets is omitted, there are four candidates for the center: (<Current X> +/- <X distance>, <Current Y> +/- <Y distance>). The center is the candidate that results in an arc with the specified orientation, not greater than 90° and with the least deviation.



Example:

```
G74*
G03*
X700Y1000I400J0D01*
```



Note: In multi quadrant mode the offsets in I and J are signed. If no sign is present, the offset is positive.



Example:

```
G75*
G03*
X-300Y-200I-300J400D01*
```



Warning: If the center is not precisely positioned, there may be none or more than one candidate fits. In that case the arc is invalid. The creator of the file accepts any interpretation.

4.10.5 Example: Single Quadrant Mode

Syntax	Comments
G74*	Set single quadrant mode
D10*	Set the current aperture to D10 aperture
X1100Y600D02*	Set the current point to (11, 6)
G03*	Set counterclockwise interpolation mode
X700Y1000I400J0D01*	Set counterclockwise interpolation mode
X300Y600I0J400D01*	Create quarter arc object (radius 4) to (7, 10)
X700Y200I400J0D01*	Create quarter arc object (radius 4) to (3, 6)
X1100Y600I0J400D01*	Create quarter arc object (radius 4) to (7, 2)
X300D02*	Create quarter arc object (radius 4) to (7, 2)
G01*	Create quarter arc object (radius 4) to (11, 6)
X1100D01*	Set the current point to (3, 6)
X700Y200D02*	Set linear interpolation mode
Y1000D01*	Create draw object to (11, 6)
	Set the current point to (7, 2)
	Create draw object to (7, 10)

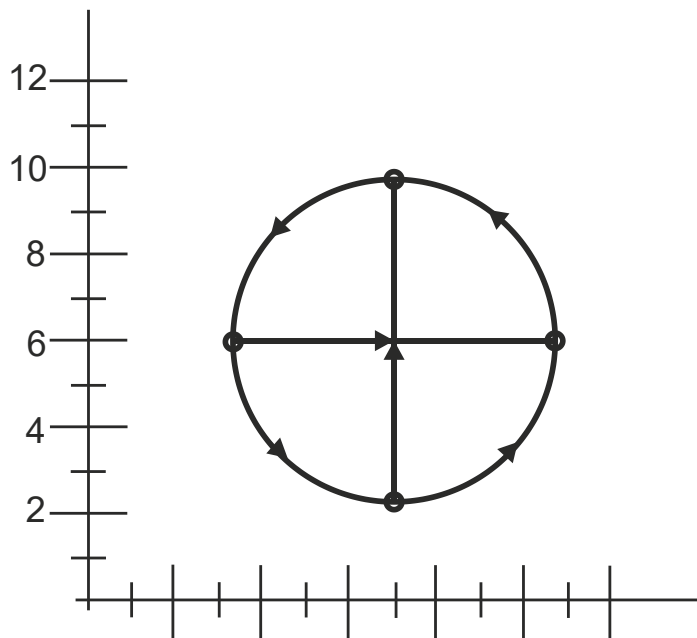

28. Single quadrant mode example: arcs and draws

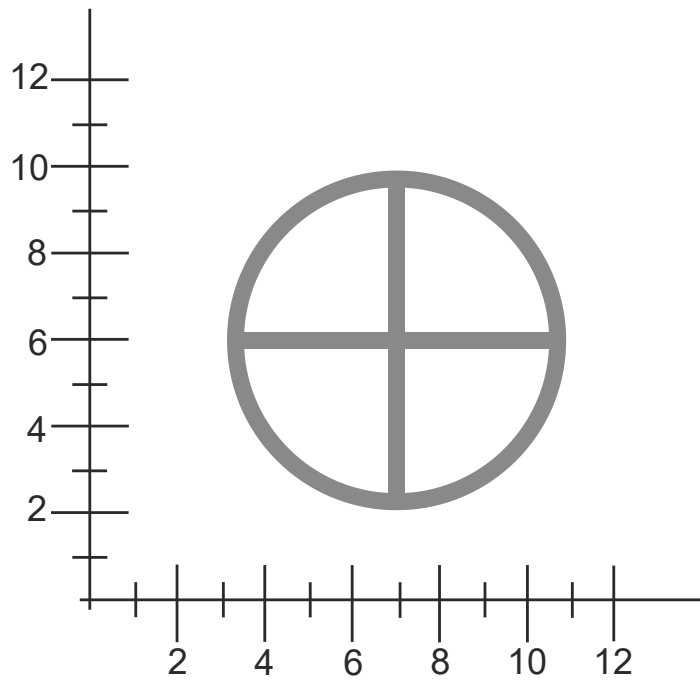

29. Single quadrant mode example: resulting image

4.10.6 Example: Multi Quadrant Mode

Syntax	Comments
X300Y-200D02* G75* G03* X-300Y-200I-300J400D01*	Set the current point to (3, -2) Set multi quadrant mode Set counterclockwise interpolation mode Create arc object counterclockwise to (-3,-2). The offsets from the start point to the center point are 3 for X and 4 for Y, i.e. the center point is (0, 2)

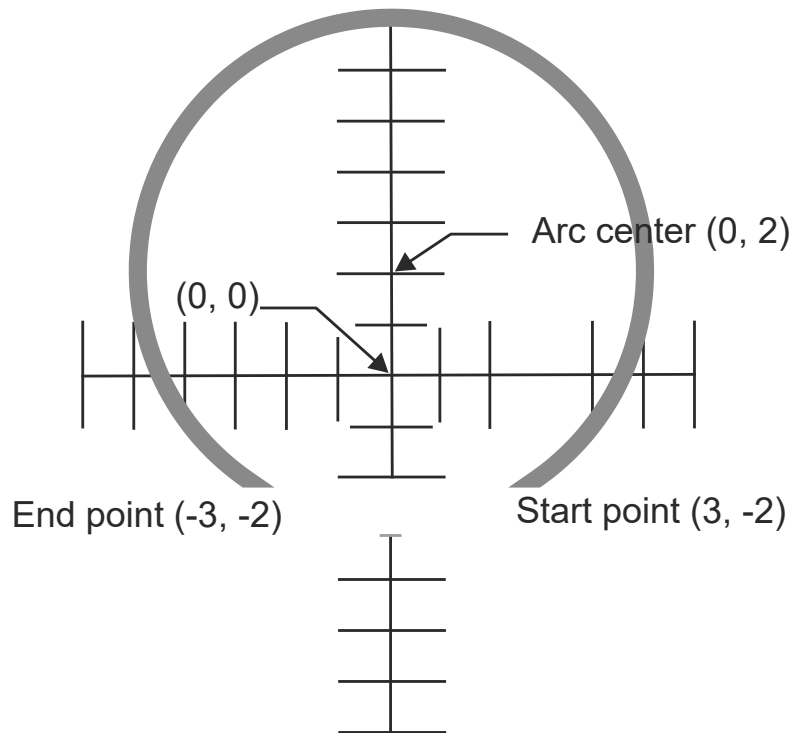

30. Multi quadrant mode example: resulting image

4.10.7 Numerical Instability in Multi Quadrant (G75) Arcs

In G75 mode small changes in the position of center point, start point and end point can swap the large arc with the small one, dramatically changing the image.

This most frequently occurs with very small arcs. Start point and end point are close together. If the end point is slightly moved it can end on top of the start point. Under G75, if the start point of the arc is equal to the end point, the arc is a full circle of 360°, see 4.10.1. A small change in the position of the end point has changed the very small arc to a full circle.

G75 rounding must be done carefully. Using high resolution is an obvious prerequisite. See 4.16.

The Gerber writer must also consider that the reader unavoidably has rounding errors. Perfectly exact numerical calculation cannot be assumed. It is the responsibility of the writer to avoid unstable arcs.

G74 arcs are always less than 90° and this numerical instability does not exist. G74 is intrinsically stable. Another option is not to use very small arcs, e.g. by replacing them with draws - the error is very small and draws are stable.

4.10.8 Using G74 or G75 May Result in a Different Image

An arc command can define a completely different image under G74 and G75. The two sample files below differ only in G74/G75, but they define a dramatically different image.

Syntax	Comments
D10*	Set the current aperture to D10 aperture
G01*	Set linear interpolation mode
X0Y600D02*	Set the current point to (0, 6)
G74*	Set single quadrant mode
G02*	Set clockwise circular interpolation mode
X0Y600I500J0D01*	Create arc object to (0, 6) with radius 5

The resulting image is small dot, an instance of the aperture at position (0, 6)

Syntax	Comments
D10*	Set the current aperture to D10 aperture
G01*	Set linear interpolation mode
X0Y600D02*	Set the current point to (0, 6)
G75*	Multi quadrant mode
G02*	Set clockwise circular interpolation mode
X0Y600I500J0D01*	Create arc object to (0, 6) with center (5,6)

The image is a full circle.

4.11 Object Transformations (LP, LM, LR, LS)

4.11.1 Overview

The commands LP, LM, LR and LS load the following object transformation graphics state parameters:

Aperture transformation commands	
Command	Parameter
LP	Polarity
LM	Mirror
LR	Rotate
LS	Scale

An object transformation parameter transforms the current aperture when it is used to create object. The transformation is temporary, after the object is created the current aperture returns to its original value. Consequently, the parameter is always applied on the original shape of the current aperture.

The polarity option directly sets the polarity of the objects. The mirror/rotate/scale parameters affect the shape of the objects by *temporarily* transforming the current aperture before the object is created. Flashes are mirrored/rotated/scaled around the flash point according to the transformation parameters. Draws and arcs (D01) are also affected; however, the only useful application seems to rotate a square aperture to align it with a draw. As the current aperture does not affect regions shape, the mirror/rotate/scale parameters do not affect the region shape either.

Object transformation parameters become effective immediately after loading and remain in effect until a new value is loaded. No other command alters the object transformation parameters. The object transformation parameters affect nor the aperture dictionary nor the current aperture.



Example on how the parameter changes affect the image

D123*	Select D123
X5000Y7000D03*	Flash D123
%LR90.0*%	Set object rotation to 90 degrees
X6000Y8000D03*	Flash D123 rotated 90 degrees
D124*	Select D124
X6000Y8000D03*	Flash D124 rotated 90 degrees
%LR0.0*%	Set object rotation to 0 degrees
X7000Y9000D03*	Flash D124, not rotated
D123*	Select D123
X1000Y2000D03*	Flash D123, this is the original, not rotated

 **Example of the effect on interpolations (draws and arcs)**

`%MOMM*%`

`%FSLAX26Y26*%`

`%ADD10C,1*%`

Define D10 as a 1mm circle

`D10*`

Select aperture 10

`G01*`

Set linear interpolation

`X00000000Y00000000D02*`

Move to origin

`X01000000D01*`

Draw a 1mm thick line

`%LS1.5*%`

Set scale factor to 1.5

`Y02000000D01*`

Draw a 1.5mm thick line

`M02*`

This results in the following image:

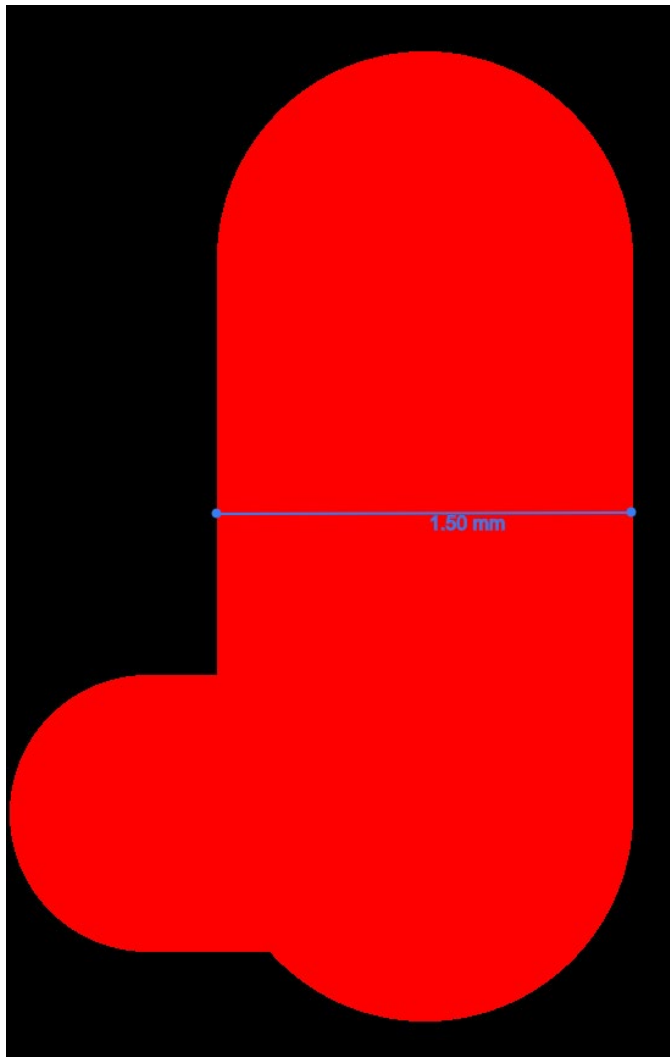

4.11.2 Load Polarity (LP)

The LP command sets the *polarity graphics state parameter*, see 2.5. It defines the polarity applied to objects when they are created. Polarity can be either *dark* or *clear*. Its effect is explained in 2.7. There is an example in 4.12.4.7.

The syntax for the LP command is:

<LP command> = LP(C|D)*

Syntax	Comments
LP	LP for Load Polarity
C D	C – clear polarity D – dark polarity

The LP command can be used multiple times in a file. The polarity remains as set until overruled by another LP command.

4.11.3 Load Mirroring (LM)

The LM command sets the *mirroring graphics state parameter*, see 2.5. The mirroring option defines the mirroring axis used when creating objects. The aperture is mirrored around its *origin* (which may not be its geometric center) before being used.

The syntax for the LM command is:

<LM command> = LM(N|X|Y|XY)*

Syntax	Comments
LM	LM for Load Mirroring
N X Y XY	N – No mirroring X – Mirroring <i>along</i> the X axis; mirror left to right; the signs of the x coordinates are inverted Y – Mirroring <i>along</i> the Y axis; mirror top to bottom; the signs of the y coordinates are inverted XY – Mirroring <i>along</i> both axes; mirror left to right and top to bottom; the signs of both the x <i>and</i> y coordinates are inverted



Mirroring is performed *before* the rotation.

The LM command can be used multiple times in a file. The mirroring remains as set until overruled by another LM command. Mirroring is set at the value in the command, it is *not* cumulated with the previous value.

The LM command was introduced in revision 2016.12.

4.11.4 Load Rotation (LR)

The LR command sets the *rotation graphics state parameter*, see 2.5. It defines the rotation angle used when creating objects. The aperture is rotated around its *origin* (which may or may not be its geometric center).

The syntax for the LR command is:

<LR command> = LR<Rotation>*

Syntax	Comments
LR	LR for Load Rotation
<Rotation>	The rotation angle, in degrees, counterclockwise. A decimal.

 Mirroring is performed *before* the rotation.

The LR command can be used multiple times in a file. The object rotation remains as set until overruled by a subsequent LR command. Rotation is set at the value in the command, it is *not* cumulated with the previous value.

The LR command was introduced in revision 2016.12.

4.11.5 Load Scaling (LS)

The LS command sets the *scaling graphics state parameter*, see 2.5. It defines the scale factor used when creating objects. The aperture is scaled centered on its *origin* (which may or may not be its geometric center).

The syntax for the LS command is:

<LS command> = LS<Scale>*

Syntax	Comments
LS	LS for Load Scaling
<Scale>	A decimal > 0.

The LS command can be used multiple times in a file. The object scaling remains as set until overruled by a subsequent LS command. Scaling is set at the value in the command, it is *not* cumulated with the previous scale factor.

The LS command was introduced in revision 2016.12.

4.11.6 Examples

Syntax	Comments
%LPD*%	Sets the object polarity to dark
%LPC*%	Sets the object polarity to clear
%LMX*%	Sets object mirroring to mirroring along the X axis
%LMN*%	Sets object mirroring to no mirroring
%LR45.0*%	Sets object rotation to 45 degrees counterclockwise
%LR-90*%	Sets object rotation to 90 degrees clockwise
%LS0.8*%	Sets object scaling to 80%



Example of a block flashed in different mirroring, orientation, scaling

```
G04 Ucamco copyright*
%TF.GenerationSoftware,Ucamco,UcamX,2016.04-160425*%
%TF.CreationDate,2016-04-25T00:00:00+01:00*%
%FSLAX26Y26*%
%MOMM*%
%ADD10C,1*%
%LPD*%
G04 Define block aperture D12*
%ABD12*%
%ADD11C,0.5*%
D10*
G01*
X-2500000Y-1000000D03*
Y1000000D03*
%LPC*%
D11*
X-2500000Y-1000000D03*
%LPD*%
X-500000Y-1000000D02*
X2500000D01*
G75*
G03*
X500000Y1000000I-2000000J0D01*
G74*
G01*
%AB*%
G04 Flash block aperture D12 in four different orientation*
D12*
X0Y0D03*
%LMX*%
X1000000D03*
%LMY*%
%LR30.0*%
X0Y800000D03*
%LMXY*%
%LR45.0*%
%LS0.8*%
X1000000D03*
%LPD*%
%LMN*%
%LR0.0*%
%LS1.0*%
M02*
```



31. Block flashed in different orientations

4.12 Region Statement (G36/G37)

4.12.1 Region Overview

A region is a graphics object defined by its contour(s) - see 4.12.3.

The G36 command begins a region statement and G37 ends it. A region statement creates contour objects by defining its contour. In a region statement the D01 and D02 commands create the contour segments. The first D01 encountered in a region statement starts the first contour by creating the first segment. Subsequent D01's add segments to it. When a D02 command is encountered the contour is considered finished. (Note that a D02 without effect on the current point, e.g. a D02*, also finishes the current contour.) A D02 is only allowed if the preceding contour is closed. The next D01 command starts a new contour. Thus an unlimited number of contours can be created between a single G36/G37 commands pair.

When a G37 command is encountered, the region statement is closed and region graphics objects are added to the object stream by filling the newly created contours. A G37 is only allowed when all contours are properly closed. A G37 finishes the last contour in the absence of a finishing D02. Each contour is filled individually. The overall filled area is the union of the filled areas of each individual contour. The number of region objects created by a single G36/G37 pair is intentionally *not* specified to leave more freedom to implementations; - for example, two overlapping contours may be merged in a single region object.

Holes in a region are defined with cut-ins (see 4.12.3 and 4.12.4.8).

D01 and D02 are the *only* D code commands allowed in a region statement; D03 and Dnn (nn≥10) are *not* allowed. Extended commands are *not* allowed. The M02 (end-of-file) command is *not* allowed. However, G code commands *are* allowed – they are needed to control the interpolation modes.

Contour segments are not in themselves graphics objects –they define the regions which are graphics objects.

Aperture attributes can be attached to a region, see 5.3.1.

4.12.2 Region Statement Syntax

The G36 and G37 commands begin and end a region statement respectively. The syntax is:

<G36 command> = G36*

<G37 command> = G37*

Syntax	Comments
G36	Begins a region statement.
G37	Ends a region statement. This creates the set of region graphics object.



Examples:

G36*

G37*

We now provide a Backus-Naur form of the region statement. The G01, G02, G03, G74, G75, D01, D02, G04 commands are the primitives in this Backus-Naur form. We first define **<iso>** as the set of interpolation state operators:

<iso> = (<G01>|<G02>|<G03>|<G74>|<G75>)

Syntactically, a contour is a sequence of interpolation state operators and draw/arc commands.

<contour> = {(<iso>|<D01>|<G04>)}

A D02 (move) separates one contour from the next.

We can now define the syntax for a region statement.

<region statement> = <G36><contour>{<D02><contour>}<G37>

A valid contour must not only comply with this syntax, but the sequence of draws/arcs must represent a connected closed contour that does not self-intersect. See 4.12.3.

4.12.3 Valid Contours

A contour is a sequence of connected linear or circular segments. A pair of segments is said to connect only if they are defined consecutively, with the second segment starting where the first one ends. Thus, the order in which the segments are defined is significant. Non-consecutive segments that meet or intersect fortuitously are not considered to connect. A contour is closed: the end point of the last segment must coincide with the start point of the first segment. A contour thus defines a closed curve.

There are two classes of valid contours.

Simple contours. A contour is said to be *simple* if all its segments are disjoint, except for consecutive segments sharing their connection points only. However, zero-length segments have no effect: readers can remove them before processing the contour. (Avoid zero-length segments as they are useless and can only cause confusion.) A simple contour does not self-intersect or self-touch. It is obvious which part of the plane lies inside the contour. The inside of the contour constitutes the region object. A simple contour defines a simple region, without holes.

Simple cut-in contours. These contours allow to create a region with holes. A cut-in connects the contour defining the hole to its enclosing contour, thus joining them into a single contour. If one travels along the contour in the direction of the segments and the inside must always be to the same side, just as for simple contours. See the illustration below; see 4.12.4.8 for a fully worked out example.

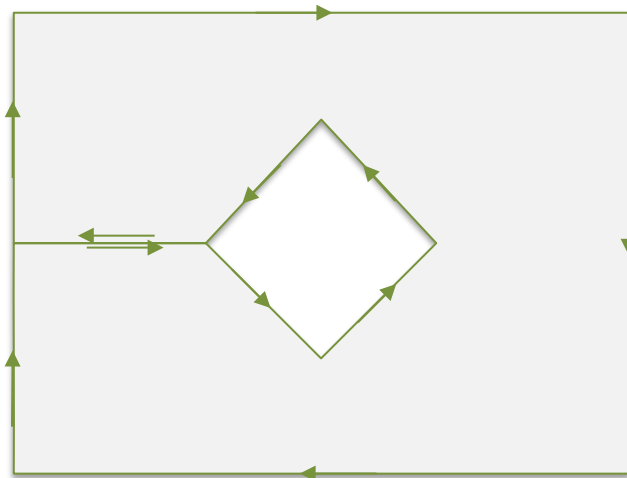

32. A contour with a cut-in

A cut-in is subject to strict requirements: it must consist of two fully coincident linear segments; a pair of linear segments are said to be fully coincident if the segments coincide completely, with the second segment starting where the first one ends; cut-ins must be either horizontal or vertical; all cut-ins in a contour must have the same direction; cut-ins cannot intersect the contour in any other location than their start and end points.

All contours except simple contours and simple cut-in contours are called *self-intersecting* and are *not allowed*. Segments *cannot* cross, overlap or touch except

- ❑ connected segments in their end points.
- ❑ cut-ins in their end points.

Any other form of self-touching or self-intersection is *not allowed*. For the avoidance of doubt, not allowed are, amongst others: segments that partially overlap, fully coincident linear segments that are diagonal, fully coincident circular segments, circular segments that are tangent to another segment, vertices on a segment at another location than its endpoints, points where more than two segments end, full arcs anywhere in a contour other than at the end of a cut-in or when the contour consist solely of that full arc.

An invalid contour has no specified interpretation.

For the mathematically inclined: A contour is said to be *weakly simple* if there exists an arbitrarily small perturbation of the vertices changing it in a simple contour. Simple contours with cut-ins are weakly simple. The winding number for valid Gerber contours is for the outside 0 and for the inside everywhere either +1 or -1, depending on the orientation. However, not all weakly simple contours or contours with these winding numbers are valid.

Contours are also used to define outline primitives in macro apertures (see 4.5.4.6).

Processing Gerber files is inevitably subject to rounding errors. Contours must be constructed robustly so that perturbations due to this rounding do not turn an otherwise valid contour in a self-intersecting one. See 4.16.2.

In Gerber, the orientation of the contour is not significant.

 **Warning:** Use maximum resolution. Low file coordinate resolution brings uncontrolled rounding and often results in self-intersecting contours, see 4.1.

 **Warning:** Sloppy construction of cut-ins can lead to self-intersecting contours – in fact this is the most prevalent cause of missed clearances in planes. Construct cut-ins carefully or avoid them altogether by making holes in regions with negative objects.

4.12.4 Examples

4.12.4.1 A Simple Contour

Syntax	Comments
G36*	Begins a region statement
X200Y300000D02*	Set the current point to (2, 3)
G01*	Set linear interpolation mode
X700000D01*	Create linear segment to (7, 3)
Y100000D01*	Create linear segment to (7, 1)
X1100000Y500000D01*	Create linear segment to (11, 5)
Y700000D01*	Create linear segment to (7, 9)
X200000D01*	Create linear segment to (7, 7)
Y300000D01*	Create linear segment to (2, 7)
G37*	Create linear segment to (2, 3)
	Create the region by filling the contour

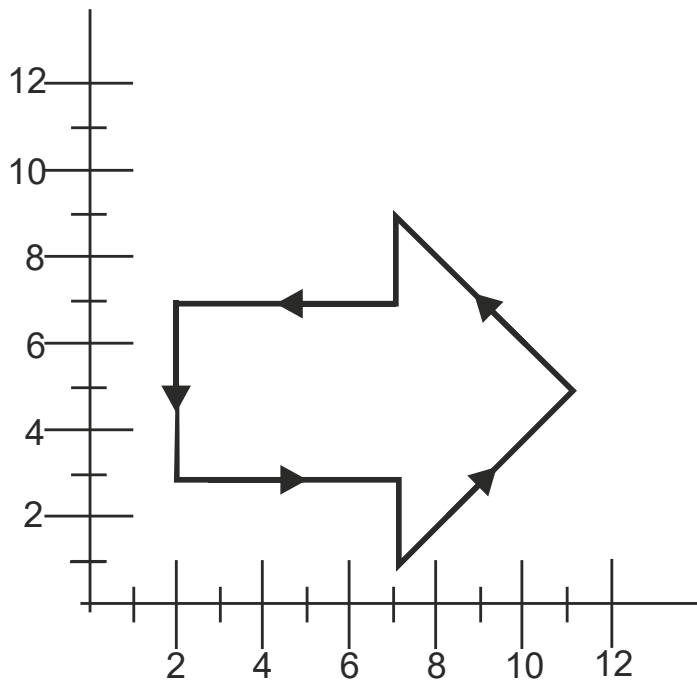

33. Simple contour example: the segments

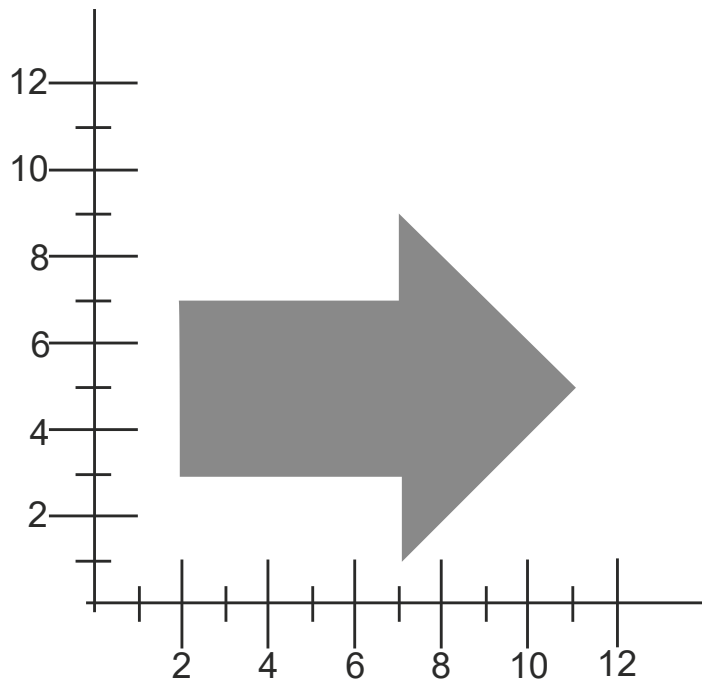

34. Simple contour example: resulting image

4.12.4.2 How to Start a Single Contour

The first D01 starts the contour at the current point, independent of how the current point is set.

Below there are three examples of similar images; differences with the previous column are highlighted and explained in the last table row.

Example 1	Example 2	Example 3
<pre>... G01* D11* ... X300Y500D01* G36* X5000Y5000D02* X6000D01* Y6000D01* X5000D01* X5000Y5000D01* G37* ...</pre>	<pre>... G01* D11* ... X300Y500D01* X5000Y5000D02* G36* X6000D01* Y6000D01* X5000D01* X5000Y5000D01* G37* ...</pre>	<pre>... G01* D11* ... X300Y500D01* X5000Y5000D01* G36* X6000D01* Y6000D01* X5000D01* X5000Y5000D01* G37* ...</pre>
<p>This sequence creates a square contour after the linear segment created by the operation:</p> <pre>X300Y500D01*</pre>	<p>Swap D02 and G36 commands. Exactly the same image.</p>	<p>Replace D02 by D01 command. The same contour is created. But the difference is that the additional draw object is added to the image by this operation:</p> <pre>X5000Y5000D01*</pre>

4.12.4.3 Use D02 to Start a Second Contour

D02 command can be used to start the new contour. All the created contours are converted to regions when the command G37 is encountered. The example below creates two non-overlapping contours which are then converted into two regions.



Example:

```
G04 Non-overlapping contours*
%FSLAX24Y24*%
%MOMM*%
%ADD10C,1.00000*%
G01*
%LPD*%
G36*
X0Y50000D02*
Y100000D01*
X100000D01*
Y0D01*
X0D01*
Y50000D01*
X-10000D02*
X-50000Y10000D01*
X-90000Y50000D01*
X-50000Y90000D01*
```



```
X-10000Y50000D01*
G37*
M02*
```

This creates the following image:

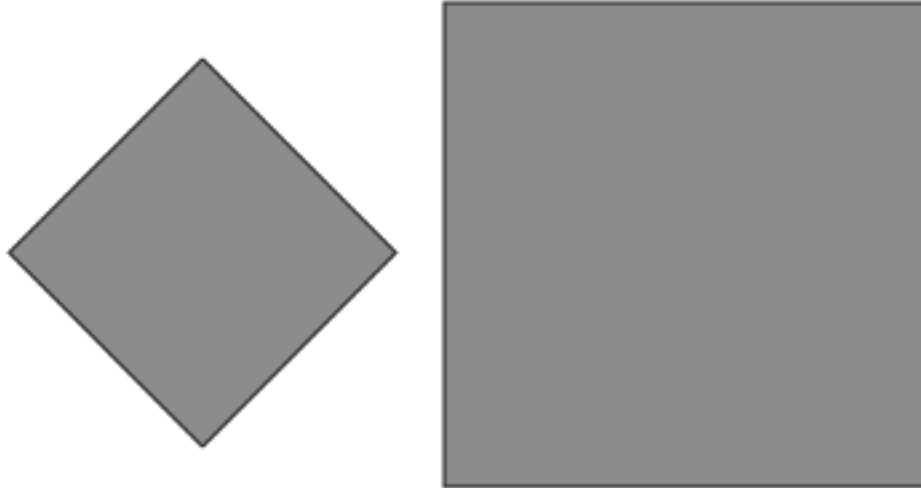

35. Use of D02 to start an new non-overlapping contour

Two different contours were created. Each contour is filled individually. The filled area is the union of the filled areas.

4.12.4.4 Overlapping Contours

The example below creates two overlapping contours which are then converted into one region.



Example:

```
G04 Overlapping contours*
%FSLAX24Y24*%
%MOMM*%
%ADD10C,1.00000*%
G01*
%LPD*%
G36*
X0Y50000D02*
Y100000D01*
X100000D01*
Y0D01*
X0D01*
Y50000D01*
X10000D02*
X50000Y10000D01*
X90000Y50000D01*
X50000Y90000D01*
X10000Y50000D01*
G37*
```

M02*

This creates the following image:

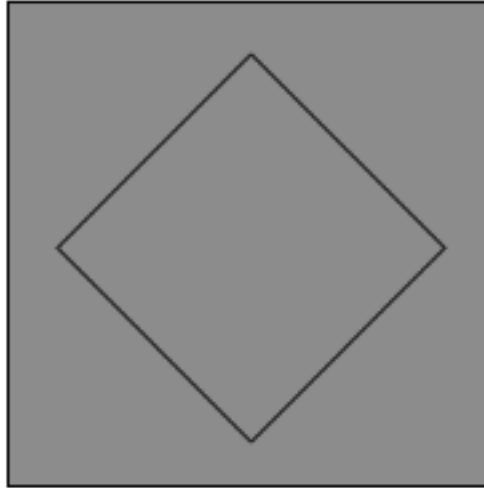

36. Use of D02 to start a new overlapping contour

Two different contours were created. Each contour is filled individually. The filled area is the union of the filled areas. As the second contour is completely embedded in the first, the effective filled area is the one of the first contour. So the created region object is the same as would be defined by the first contour only.

4.12.4.5 Non-overlapping and Touching

The example below creates two non-overlapping touching contours which are then converted into one region.



Example:

```
G04 Non-overlapping and touching*
%FSLAX24Y24*%
%MOMM*%
%ADD10C,1.00000*%
G01*
%LPD*%
G36*
X0Y50000D02*
Y100000D01*
X100000D01*
Y0D01*
X0D01*
Y50000D01*
D02*
X-50000Y10000D01*
X-90000Y50000D01*
X-50000Y90000D01*
X0Y50000D01*
```

G37*
M02*

This creates the following image:

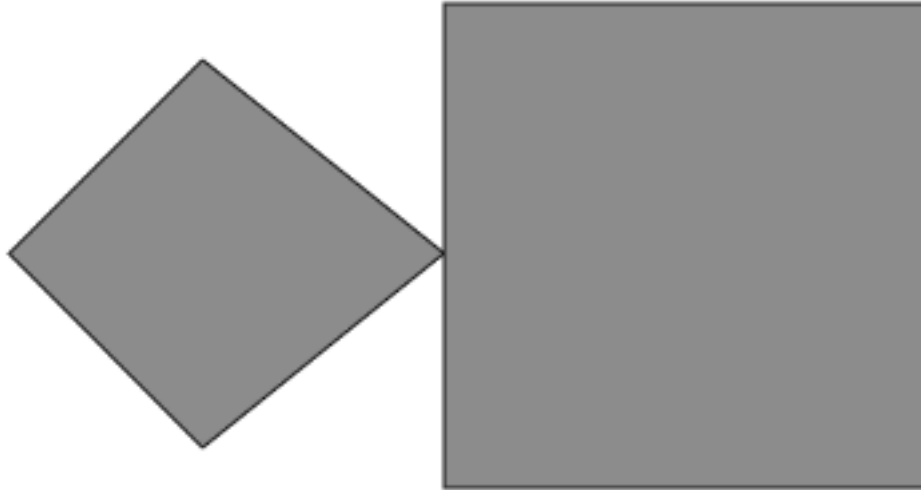

37. Use of D02 to start an new non-overlapping contour

As these are two different contours in the same region touching is allowed.

4.12.4.6 Overlapping and Touching

The example below creates two overlapping touching contours which are then converted into one region.



Example:

```
G04 Overlapping and touching*
%FSLAX24Y24*%
%MOMM*%
%ADD10C,1.00000*%
G01*
%LPD*%
G36*
X0Y50000D02*
Y100000D01*
X100000D01*
Y0D01*
X0D01*
Y50000D01*
D02*
X50000Y10000D01*
X90000Y50000D01*
X50000Y90000D01*
X0Y50000D01*
G37*
M02*
```

This creates the following image:

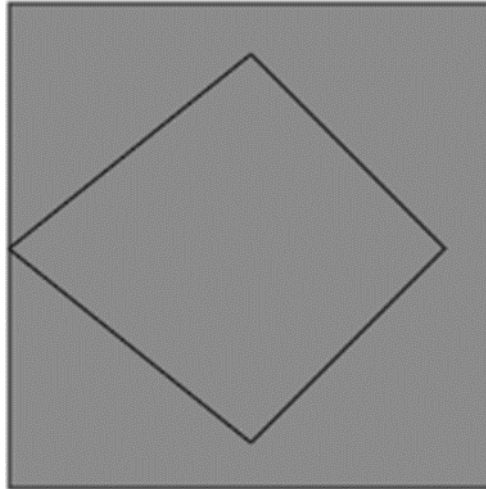

38. Use of D02 to start an new overlapping and touching contour

As these are two different contours in the same region touching is allowed.

4.12.4.7 Using Polarity to Create Holes

The recommended way to create holes in regions is by alternating dark and clear polarity, as illustrated in the following example. Initially the polarity mode is dark. A big square region is generated. The polarity mode is set to clear and a circular disk is added to the object stream; the disk is cleared from the image and creates a round hole in the big square. Then the polarity is set to dark again and a small square is added to the stream, darkened the image inside the hole. The polarity is set to clear again and a small disk added, clearing parts of the big and the small squares.



Example:

```
G04 This file illustrates how to use polarity to create holes*
%FSLAX25Y25*%
%MOMM*%
G01*
G04 First object: big square - dark polarity*
%LPD*%
G36*
X2500000Y2500000D02*
X1750000D01*
Y1750000D01*
X250000D01*
Y250000D01*
G37*
G04 Second object: big circle - clear polarity*
%LPC*%
G36*
G75*
X500000Y1000000D02*
```

G03*
X5000000Y10000000I5000000J0D01*
G37*
G04 Third object: small square - dark polarity*
%LPD*%
G01*
G36*
X7500000Y7500000D02*
X12500000D01*
Y12500000D01*
X7500000D01*
Y7500000D01*
G37*
G04 Fourth object: small circle - clear polarity*
%LPC*%
G36*
G75*
X11500000Y10000000D02*
G03*
X11500000Y10000000I2500000J0D01*
G37*
M02*

Below there are pictures which show the resulting image after adding each object.



39. Resulting image: first object only



40. Resulting image: first and second objects



41. Resulting image: first, second and third objects



42. Resulting image: all four objects

4.12.4.8 A Simple Cut-in

The example below illustrates how a simple cut-in can be used to create a hole in a region. The coinciding contour segments must follow the requirements defined in 4.12.3.

Syntax	Comments
%FSLAX26Y26*%	Format specification
...	Set multi quadrant mode
G75*	Begins a region statement
G36*	Set the current point to (2,10)
X20000Y10000000D02*	Set linear interpolation mode
G01*	Create linear contour segment to (12,10)
X12000000D01*	Create linear contour segment to (12, 2)
Y20000000D01*	Create linear contour segment to (2, 2)
X2000000D01*	Create linear contour segment to (2, 6)
Y6000000D01*	Create linear contour segment to (2, 6)
X5000000D01*	Create linear contour segment to (5, 6), 1 st fully coincident segment
G03*	Set counterclockwise circular interpolation mode
X50000Y60000I30000J0D01*	Create counterclockwise circle with radius 3
G01*	Set linear interpolation mode
X20000D01*	Create linear contour segment to (2, 6), 2 nd fully coincident segment
Y100000D01*	Create linear contour segment to (2, 10)
G37*	Create the region by filling the contour

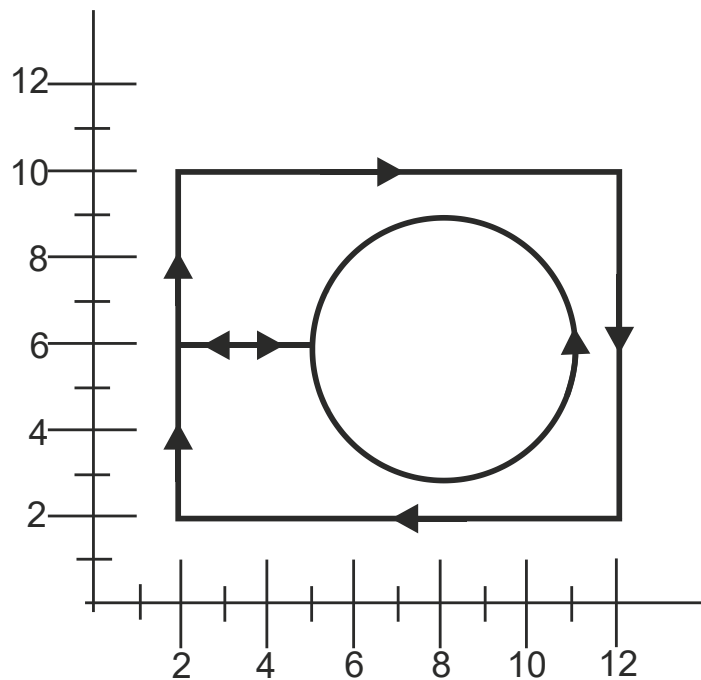

43. Simple cut-in: the segments

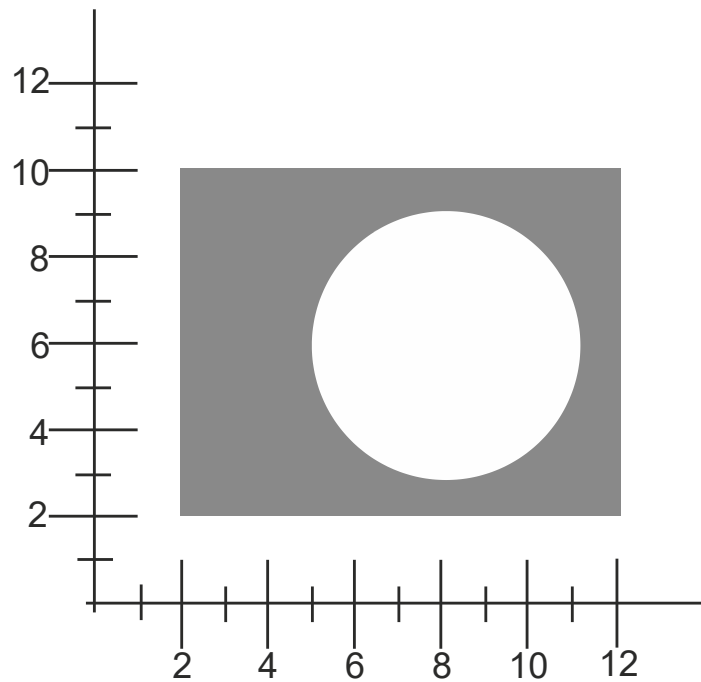

44. Simple cut-in: the image

Note the orientation of the inner circle. If the orientation would be different the contour would be self-intersecting. This becomes immediately apparent if you try to perturb the contour to convert it to a simple contour.

4.12.4.9 Fully Coincident Segments

The first example below illustrates how one contour may result in two regions. This happens because there are two fully coincident linear segments which give the gap between filled areas.



Example:

```
G04 ex1: non overlapping*
%FSLAX24Y24*%
%MOMM*%
%ADD10C,1.00000*%
G01*
%LPD*%
G36*
X0Y50000D02*
Y100000D01*
X100000D01*
Y0D01*
X0D01*
Y50000D01*
G04 first fully coincident linear segment*
X-10000D01*
X-50000Y10000D01*
X-90000Y50000D01*
```

```
X-50000Y90000D01*  
X-10000Y50000D01*  
G04 second fully coincident linear segment*  
X0D01*  
G37*  
M02*
```

This creates the following image:

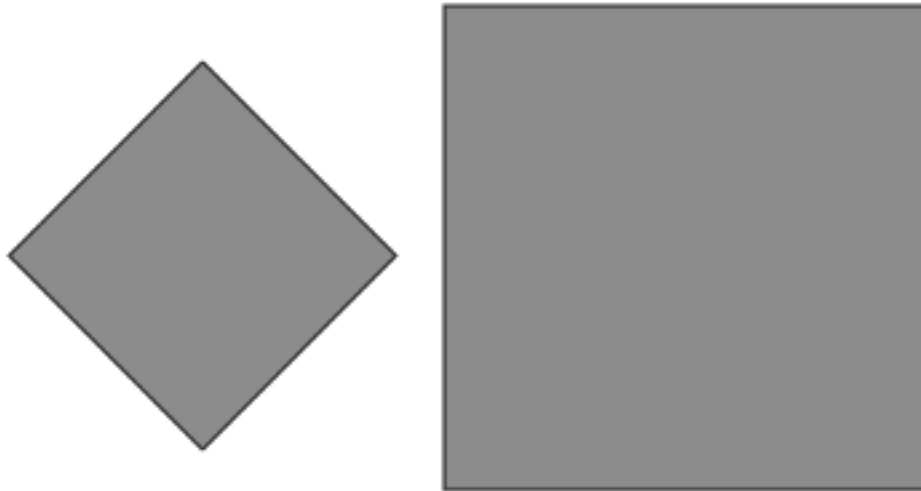

45. Fully coincident segments in contours: two regions

The second example illustrates how one contour allows creating region with hole.



Example:

```
G04 ex2: overlapping*  
%FSLAX24Y24*%  
%MOMM*%  
%ADD10C,1.00000*%  
G01*  
%LPD*%  
G36*  
X0Y50000D02*  
Y100000D01*  
X100000D01*  
Y0D01*  
X0D01*  
Y50000D01*  
G04 first fully coincident linear segment*  
X10000D01*  
X50000Y10000D01*  
X90000Y50000D01*  
X50000Y90000D01*  
X10000Y50000D01*
```

```
G04 second fully coincident linear segment*  
X0D01*  
G37*  
M02*
```

This creates the following image:

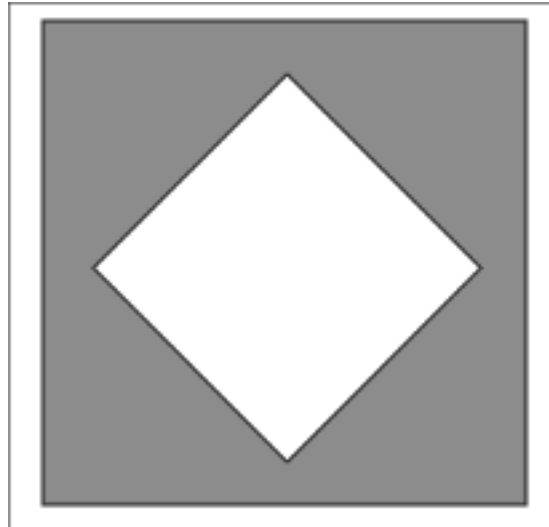

46. Fully coincident segments in contours: region with hole

4.12.4.10 Valid and Invalid Cut-ins

Contours with cut-ins are susceptible to rounding problems: when the vertices move due to the rounding the contour may become self-intersecting. This may lead to unpredictable results. The first example below is a cut-in with valid fully coincident segments, where linear segments which are on top of one another have the *same* end vertices. When the vertices move due to rounding, the segments will remain exactly on top of one another, and no self-intersections are created. This is a valid and robust construction.



Example:

```
G36*  
X1220000Y2570000D02*  
G01*  
Y2720000D01*  
X1310000D01*  
Y2570000D01*  
X1250000D01*  
Y2600000D01*  
X1290000D01*  
Y2640000D01*  
X1250000D01*  
Y2670000D01*  
X1290000D01*  
Y2700000D01*  
X1250000D01*  
Y2670000D01*  
Y2640000D01*
```

Y2600000D01*
Y2570000D01*
X1220000D01*
G37*

This results in the following contour:

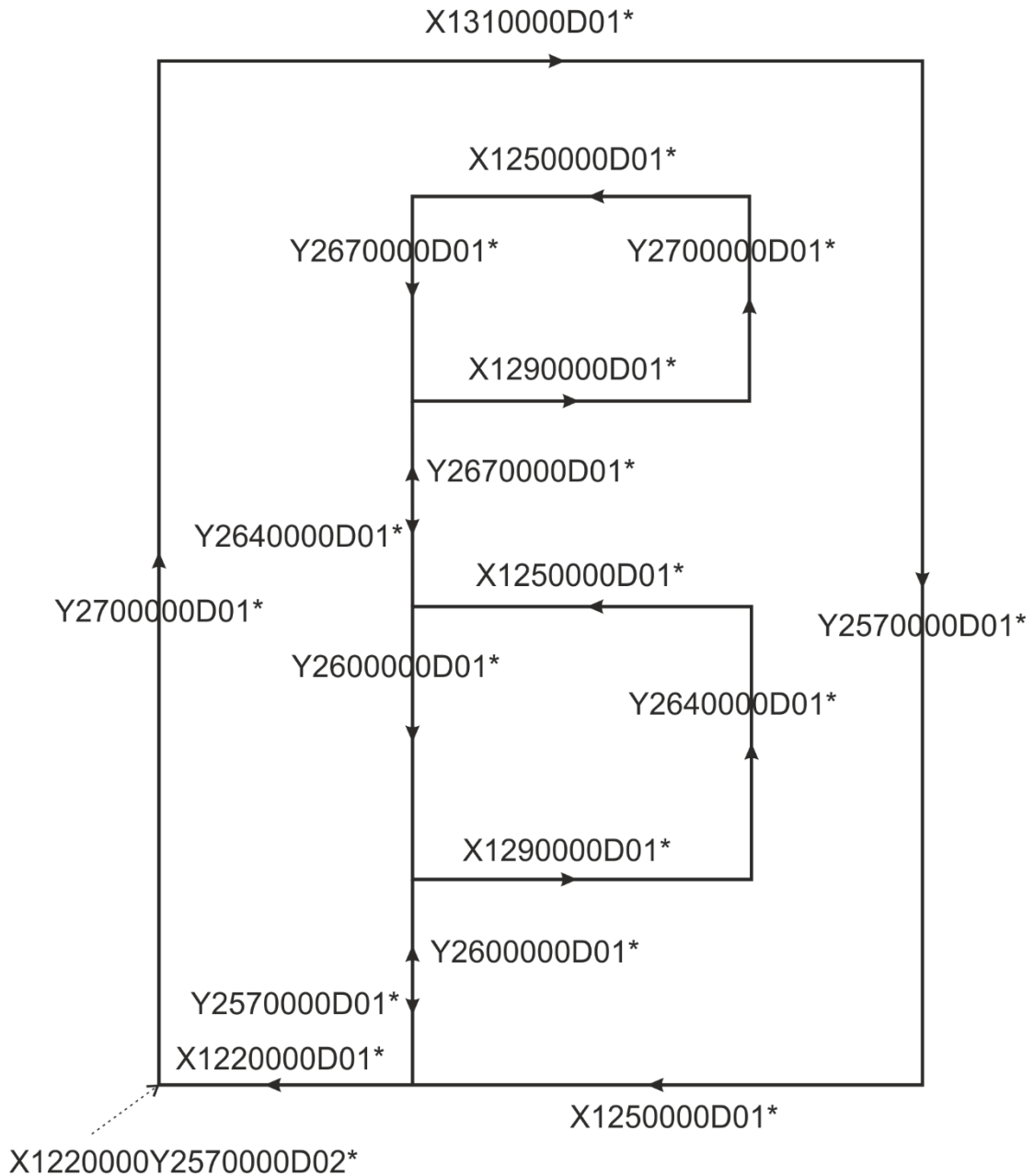

47. Valid cut-in: fully coincident segments

This creates the following image:

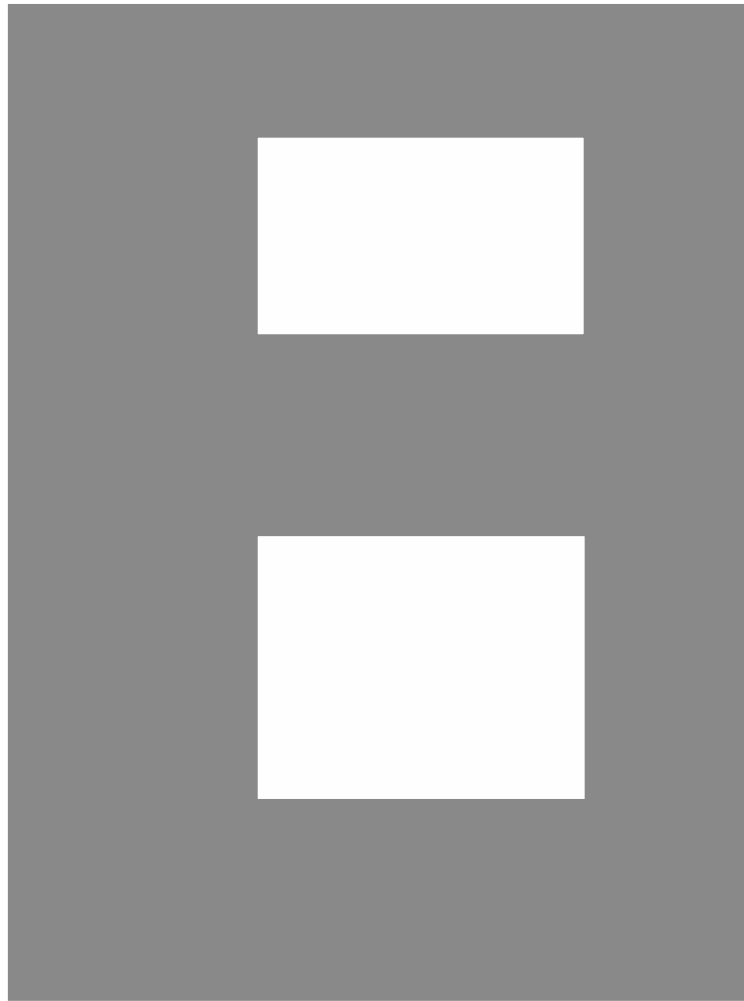

48. Valid cut-in: resulting image

The next example attempts to create the same image as the first example from above, but it is *invalid* due to the use of invalid partially coinciding segments (see the description of a valid contour in 4.12.3). The number of linear segments has been reduced by eliminating vertices between collinear segments, creating invalid overlapping segments. This construction is *invalid*. It is prohibited because it is not robust and hard to handle: when the vertices move slightly due to rounding, the segments that were on top of one another may become intersecting, with unpredictable results.



Example:

```
G36*  
X1110000Y2570000D02*  
G01*  
Y2600000D01*  
X1140000D01*  
Y2640000D01*  
X1110000D01*  
Y2670000D01*  
X1140000D01*  
Y2700000D01*  
X1110000D01*
```

Y2570000D01*
X1090000D01*
Y2720000D01*
X1170000D01*
Y2570000D01*
X1110000D01*
G37*

This results in the following contour:

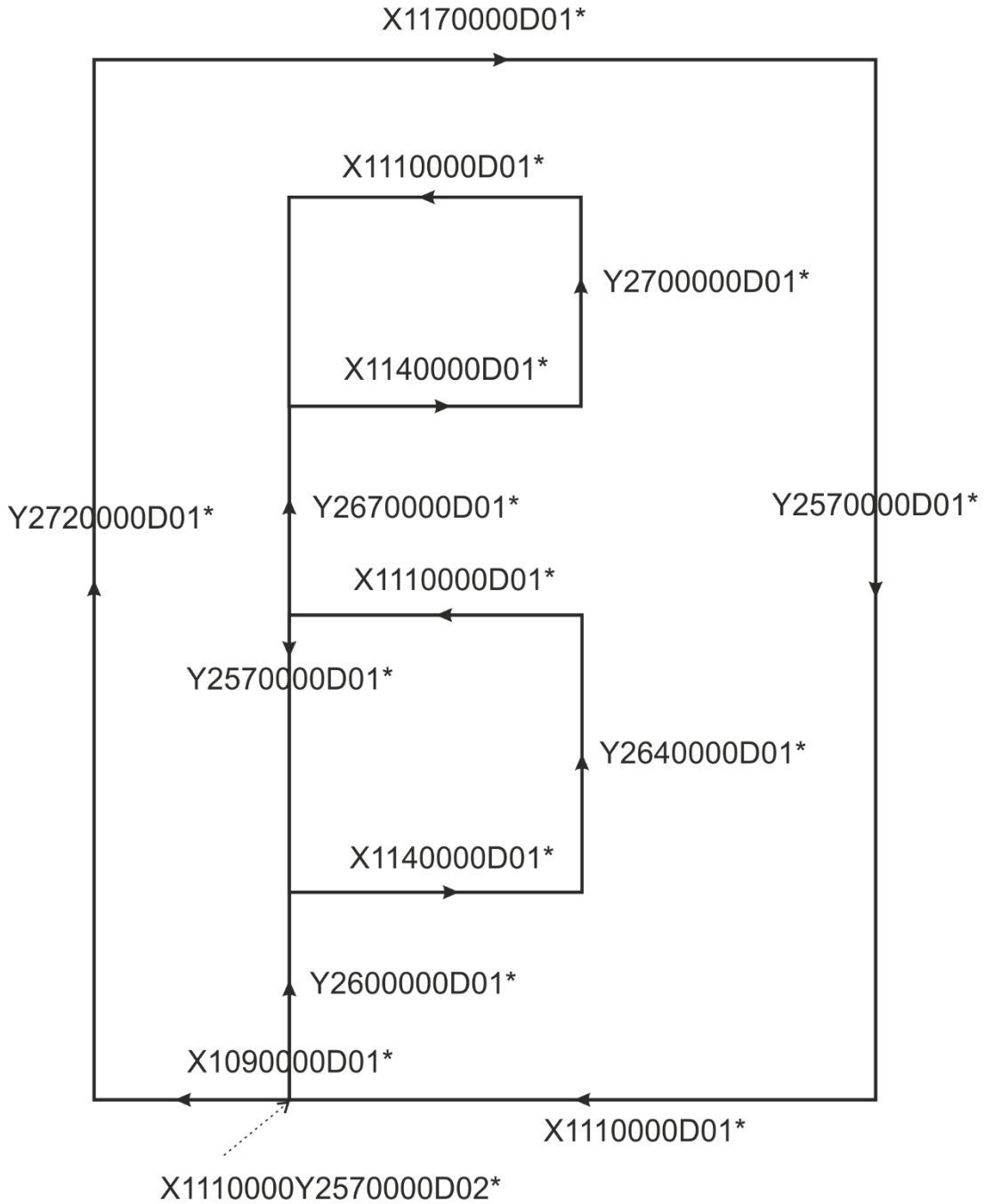

49. Invalid cut-in: overlapping segments

4.12.5 Power and Ground Planes

The simplest way to construct power and ground planes is first to create the copper pour with a region in dark polarity (LPD), and then erase the clearances by switching to clear polarity (LPC) and flash the anti-pads.



Example:

```
G04 We define the antipad used to create the clearances*
%TA.AperFunction,AntiPad*%
%ADD11C...*%
...
G04 We now define the copper pour as a region*
LPD*
G36*
X...Y...D02*
X...Y...D01*
...
G37*
G04 We now flash clearances*
%LPC*%
D11*
X...Y...D03*
```

This is simple and clear. In the CAD layout, the location of the anti-pads is known. With negative anti-pads this information is transferred directly to CAM in a simple way.

Clearances in power and ground planes can also be constructed with cut-ins, as below.

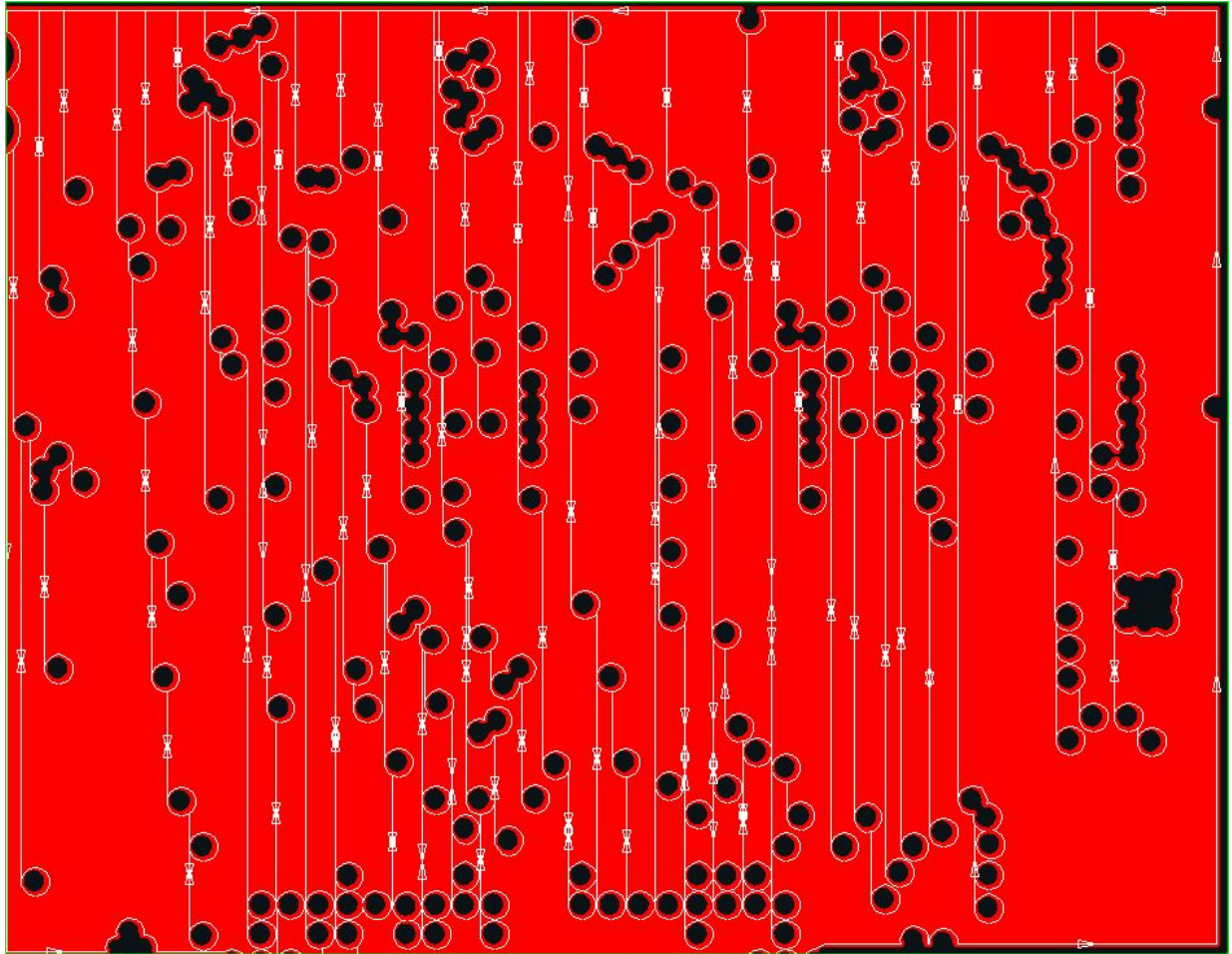

50. Power and ground planes with cut-ins.

The cut-ins are rather complex to create on output; on input in CAM the cut-ins must be removed and the original clearances restored, again rather complex. Use this more complex construction only if there is a good reason not to use the anti-pad method.

Care must be taken to only create valid cut-ins. Sloppy cut-ins are the most frequent cause of scrap due to faulty Gerber files, causing a self-intersecting contour and a missing clearance. Below is an example of such sloppy cut-in; it is a real-life example that lead to expensive scrap. Watch out for rounding errors. Make sure that coincident points indeed are coincident in the file. Using the highest resolution on outputs reduces rounding errors.

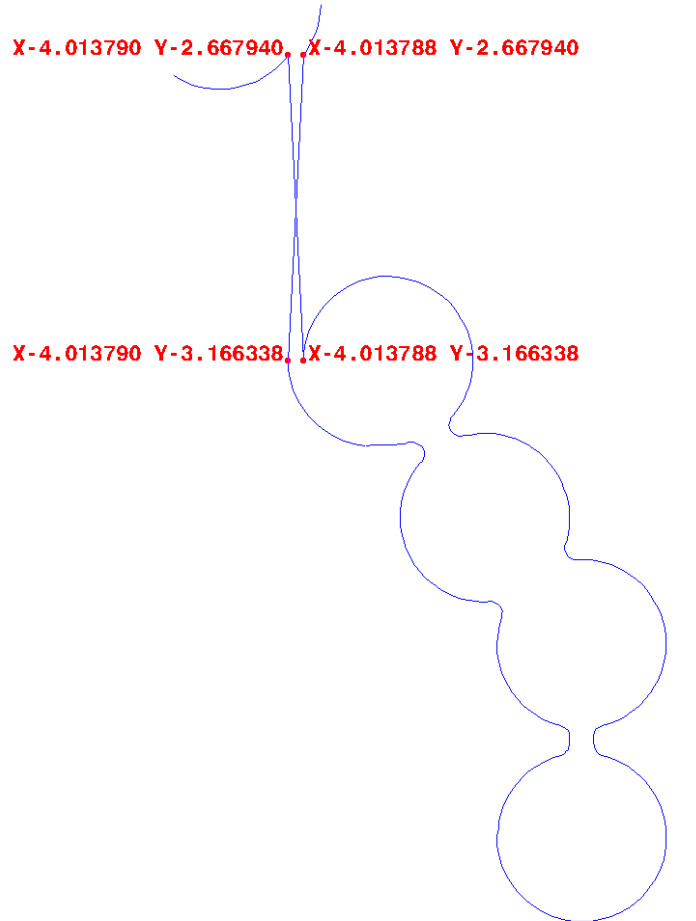

51. Power plane with invalid cut-in.

It is sometimes recommended to avoid the cut-ins altogether by splitting the plane in separate pieces, where no piece has holes. Do not follow this terrible recommendation. The remedy is worse than the disease. Splitting the single contour in separate contours without holes is as complex as adding cut-ins. All clearance boundaries must be cut in pieces and split over different contours; not much of an improvement over finding cut-in points. Rounding errors still lurk, and can lead to pieces that are no longer connected; not much of an improvement over invalid cut-ins. The situation is far worse on input. If the plane consists of a single contour it is clear it is a single plane. When planes are split in pieces the coherence is lost. The file reader must figure out from a bewildering set of contours that a single plane is intended. It must recover clearances which boundaries are scattered over different contours. Cutting a plane in pieces to avoid clearances is bad practice. It is asking for problems. See also 4.16.

4.13 Step and Repeat (SR)

The purpose of the SR command is to replicate a set of graphics objects without replicating the commands that creates the set.

The SR command `%SRX...Y...I...J...*%` opens an *SR statement*. All subsequent commands are part of the SR statement until it is closed by an `%SR*%`. The parameters X, Y specify the number of repeats in X and Y and I, J their respective step distances. The graphics objects generated by the command stream in a SR statement are collected in a *block* - see 2.8 - instead of being added directly to the object stream. When the SR command is closed by an `%SR*%`, the block is step-repeated (replicated) in the image plane according to the parameters X, Y, I and J in the opening SR command. Blocks are copied first in the positive Y direction and then in the positive X direction. The syntax for the SR command is:

<SR command> = SR[X<Repeats>Y<Repeats>I<Distance>J<Distance>]*

Syntax	Comments
SR	SR for Step and Repeat
X<Repeats>	Defines the number of times the block is repeated along the X axis <Repeats> is an integer ≥ 1
Y<Repeats>	Defines the number of times the block is repeated along the Y axis <Repeats> is an integer ≥ 1
I<Distance>	Defines the step distance along the X axis <Distance> is a decimal number ≥ 0 , expressed in the unit of the MO command
J<Distance>	Defines the step distance along the Y axis <Distance> is a decimal number ≥ 0 , expressed in the unit of the MO command

Examples:

Syntax	Comments
<code>%SRX2Y3I2.0J3.0*%</code>	Opens an SR statement and starts block accumulation When block accumulation is finished the block will be repeated 2 times along the X axis and 3 times along the Y axis. The step distance between X-axis repeats is 2.0 units. The step distance between Y-axis repeats is 3.0 units.
<code>%SRX4Y1I5.0J0*%</code>	Opens an SR statement and starts block accumulation When block accumulation is finished the block will be repeated 4 times along the X axis with the step distance of 5.0 units. The step distance in the J modifier is ignored because no repeats along the Y axis are specified.
<code>%SR*%</code>	Closes the SR statement and repeats the previously accumulated block

To define the Backus-Naur form of the SR statement we use the following primitives:

<single command> = all commands except SR, AB, G36, G37 and M02

<region statement> see 4.12

The Backus-Naur form of the SR statement is then:

<SR open> = %SRX<Repeats>Y<Repeats>I<Step>J<Step>*%

<SR close> = %SR*%

<SR statement> = <SR open>{<single command>|<region statement>}<SR close>



Example:

```
G04 A block of two flashes is repeated 3x2 times*
%SRX3Y2I5.0J4.0*%
D13*
X123456Y789012D03*
D14*
X456789Y012345D03*
%SR*%
```

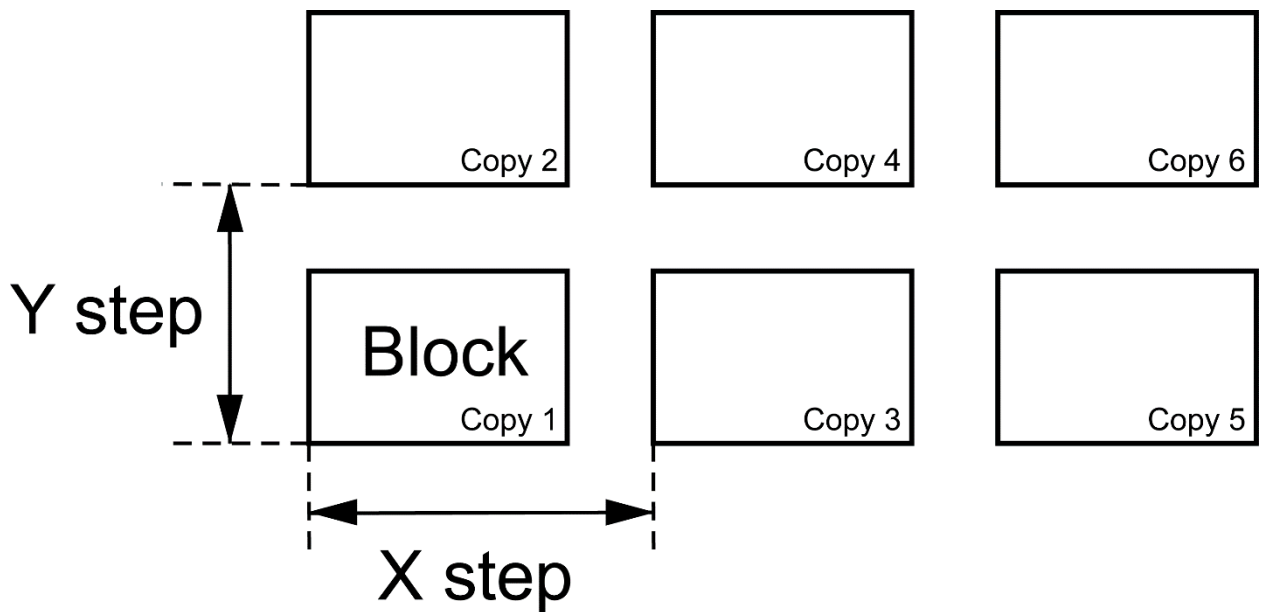

52. Blocks replication with SR command

Note that a block contains the graphics objects, not the Gerber source code. The graphics objects in each copy are always identical, even if the graphics state is modified during the SR statement.

The current point is undefined after an SR statement.

A file can contain multiple SR statements. The number of steps and the step distances can be different in X and Y. The number of repeats along an axis can be one; it is then recommended to use the step distance 0.

A step & repeat block can contain different polarities (LPD and LPC – see 4.11.2). A clear object in a block clears *all* objects beneath it, including objects outside the block. When repeats of

blocks with both dark and clear polarity objects overlap, the step order affects the image; the correct step order must therefore be respected: step the complete block first in Y and then in X.

 **Warning:** As the correct order is not correctly implemented in some Gerber readers, it is prudent to avoid overlapping blocks containing both clear and dark polarity objects. Overlapping blocks where all objects have identical polarity are safe.

4.14 Comment (G04)

The G04 command is used for human readable comments. It does not affect the image. Gerber readers must ignore the command when generating the image.

The syntax for G04 is as follows.

<G04 command> = G04<Comment content>*

The <Comment content> must follow the syntax for strings in section 3.6.6.

Content starting with " #@! " is reserved for *standardized* comments. They can only be used as defined in the specification. Gerber readers must of course also ignore such comments when generating the image.



Example:

```
G04 This is a comment*
```

```
G04 The space characters as well as \, ' and \;' are allowed here.*
```

4.15 End-of-file (M02)

The M02 command indicates the end of the file.

The syntax for M02 is as follows:

<M02 command> = M02*



Example:

M02*

The last command in a Gerber file *must* be the M02 command. No data is allowed after an M02. Gerber readers are encouraged to give an error on a missing M02 as this is an indication that the file has been truncated.

Note that a block or region statement must be explicitly closed. Consequently, an M02 command *cannot* be issued *within* a block or region statement.

4.16 Numerical Accuracy in Image Processing and Visualization

The coordinates of all points and all geometric parameters (e.g. a diameter) have an exact numerical value. Graphics objects are therefore in principle defined with infinite precision with the exception of arcs, which are intrinsically slightly fuzzy (see 4.10.1.). A Gerber file specifies an image with infinite precision.

However, Gerber file writers cannot assume that file readers will process their files with infinite precision as this is simply impossible. *Nemo potest ad impossibile obligari*. This raises the question to what a Gerber file reader is held, and what a Gerber writer *can* assume.

4.16.1 Visualization

Gerber files are often used to *visualize* an image on a screen, a photoplotter, a direct imager. Visualization is unavoidably constrained by the limitations of the output device. Nonetheless, visualization must comply with the following rules:

- Each individual graphics object must be rendered within the stated accuracy of the output device.
- No spurious holes may appear - solid objects must be visualized solid.
- No spurious objects may appear.
- Zero-size objects are *not* visualized.
- Graphics object can be rendered individually, without considering neighboring objects. In other words, each graphics object is handled individually, regardless of context.

It is intentionally not specified if rendering must be “fat” or “thin” - fat meaning that features below the device accuracy are blown up to be visible, thin meaning that they disappear.

These rules have several noteworthy consequences:

- Gerber objects separated by a very small gap may touch in the visualized image.
- Gerber objects that touch or marginally overlap may be separated by a gap in the visualized image.
- Gerber objects smaller or thinner than the device resolution may totally disappear in the visualized image.
- When what is intended to be a single object is broken down in simpler graphics objects, and these elementary objects do not sufficiently overlap, the resulting image may *not* be solid - it may have internal holes or even break up in pieces. To avoid these effects the best and most robust approach is not to break up the single object at all: the Gerber format has powerful primitives to create almost any shape with a single graphics object or possible a succession of dark and clear objects.

Construct files robustly.

4.16.2 Image Processing

Gerber files are processed for visualization but often also to complex image processing algorithms: e.g. etch compensation, design rule checks in CAM and so on. These algorithms perform long sequences of numerical calculations. Rounding errors unavoidably accumulate. This means that all coordinates can move and object sizes can vary. The specification limits the allowed perturbation to $[-0.5\mu\text{m}, +0.5\mu\text{m}]$; furthermore coincident coordinates must remain

coincident. The writer can assume that the perturbation is within this limit. Higher accuracy cannot be blindly assumed; if it is needed it must be checked that the applications downstream can handle this. A file is therefore only robust if, under any allowed perturbation, it remains valid and represents the same image.

The perturbation has some noteworthy consequences:

- ❑ Contours that are not self-intersecting by a margin of $\leq 1\mu\text{m}$ can become self-intersecting under a valid perturbation. Such contours are therefore invalid; see section 4.12.3. Contours must be constructed robustly so that allowed processing perturbations do not turn an otherwise valid contour in a self-intersecting one. See 4.16.2. Consequently, points and segments that are not coincident must be separated by at least $1\mu\text{m}$. Furthermore, circular segments add their own intrinsic fuzziness, see 4.10.1. If any valid interpretation of the arc violates the requirement of $1\mu\text{m}$ separation the contour is invalid. Construct contours defensively. Observe sufficient clearances. Marginal contours can and do lead to problems
- ❑ Objects that touch or overlap marginally can become separated under perturbation. This is important for electrical connection. An electrical connection that is realized by touching objects can get separated by a valid perturbation. Such marginal construction can be validly interpreted as either isolating or connecting. Make proper and robust electrical connections, with an overlap of the order of magnitude of at least the minimum conductor width.
- ❑ Arcs with end points separated by less than $1\mu\text{m}$ can toggle between very small or nearly 360 degrees under valid perturbations. Do not write such arcs.
- ❑ Avoid objects smaller than $1\mu\text{m}$.

Construct files robustly.

5 Attributes

5.1 Attributes Overview

Attributes add meta-information to a Gerber file. Attributes are akin to labels providing information about the file or features within them. Examples of meta-information conveyed by attributes are:

- ❑ The function of the file in the layer structure. Is the file the top solder mask, the bottom copper layer, ...?
- ❑ The function of a pad. Is the pad an SMD pad, or a via pad, or a fiducial, ...?

The attribute syntax provides a flexible and standardized way to add meta-information to a Gerber file, independent of the specific semantics or application.

Attributes do *not* affect the image. A Gerber reader will generate the correct image if it simply ignores the attributes.

Each attribute consists of an *attribute name* and an optional *attribute value*:

<Attribute> = <AttributeName>[,<AttributeValue>]*

Attribute names follow the name syntax in section 3.6.5.

The attribute value consists of one or more comma-separated fields, see section 3.6.7.

<AttributeValue> = <Field>{,<Field>}

There are three types of attributes by the *item* they attach to:

Attachment type	The item to which they attach meta-information
File attributes	Attach meta-information to the file as a whole.
Aperture attributes	Attach meta-information to an aperture or a region. Objects created by the aperture inherit the aperture meta-information
Object attributes	Attach meta-information to on object directly

There are two types of attributes by the *scope* of their use:

- ❑ *Standard attributes.* Standard attribute names, values and semantics are defined in this specification and are part of it. As they are standardized they can exchange meta-information between all applications.
- ❑ *User attributes.* User attributes can be chosen freely by users to extend the format with custom meta-information. Use custom attributes only for unequivocally defined machine-readable information, use G04 for mere human-readable comments.

In accordance with the general rule in 3.6.5 standard attribute names *must* begin with a dot '.' while user attribute names *cannot* begin with a dot. The dot, if present, is part of the attribute name and indicates that it is a standard attribute whose syntax and semantics are defined in section 5.6.



Example of a user attributes:

```
%TFMyAttribute, Yes*%
%TFZap*%
```

%TFZonk*%

The following commands govern attributes. (They start with a T as the more obvious A is already taken by the aperture commands.)

Command	Description	Section
TF	Attribute file. Set a file attribute.	5.2
TA	Attribute aperture. Add an aperture attribute to the dictionary or modify it.	5.3
TO	Attribute object. Add an object attribute to the dictionary or modify it.	5.4
TD	Attribute delete. Delete one or all attributes in the dictionary.	5.5

During the processing of a Gerber file an *attribute dictionary* is maintained. Dictionary entries consist of the attribute name, its domain and its value. The attribute name is the key of the entry; it must consequently be unique, even for attributes with a different domain.

The current aperture dictionary is defined after each command by the following rules:

- Initially the attribute dictionary is empty
- File attributes are added with the TF command
- Aperture attributes are added or updated with the TA command
- Object attributes are added or updated with the TO command
- Attributes are deleted with the TD command

When an aperture or a graphics object is created all attributes with the proper domain present in the dictionary at the time of creation are attached to it. They remain fixed and cannot be changed.

In the following example the command TF defines an attribute with name “.FileFunction” and value composed of the two fields: “Soldermask,Top”.



Example:

```
%TF.FileFunction,Soldermask,Top*%
```

Note that attribute commands are not allowed *within* a region statement, see 4.12.2.

5.2 File Attributes (TF)

File attributes provide meta-information about entire files.

The semantics of a file attribute specifies where it must be defined, typically in the header of the file. A file attribute can only be defined once. It cannot be redefined.

File attributes are set using the uppercase TF command using the following syntax

```
<TF command> = %TF<AttributeName>[,<AttributeValue>]*%
<AttributeValue> = <Field>{,<Field>}
```

The attribute name must follow the syntax in section 3.6.5, fields this in 3.6.7. The name is unique and cannot be used for any other attribute, even of another type.



Example:

```
%TF.FilePolarity,Negative*%
```

5.3 Aperture Attributes (TA)

An *aperture attribute* is attached to an aperture or a region. They typically provide information about the graphics objects that will be created with the aperture; for example, a via attribute on an aperture means that all pads flashed with this aperture are via pads. Providing information about graphics objects via their apertures is elegant, compact and efficient.

The TA command adds an aperture attribute into the attributes dictionary. It has the following syntax:

```
<TA command> = %TA<AttributeName>[,<AttributeValue>]*%
<AttributeValue> = <Field>{,<Field>}
```

The attribute name must follow the syntax in section 3.6.5, fields the one in 3.6.7. The name must be unique. The value of an aperture attribute can be modified by a new TA with the same attribute name.

The example below defines several attributes.



Example:

```
%TA.AperFunction,ComponentPad*%
%TAMyApertureAttributeWithValue,value*%
%TAMyApertureAttributeWithoutValue*%
```

In the next example the aperture value is initially set to `ComponentPad` and later overruled to `ViaPad`.



Example:

```
%TA.AperFunction,ComponentPad*%
...
%TA.AperFunction,ViaPad*%
```

When an AD or an AB command creates an aperture all aperture attributes then in the attribute dictionary are attached to it. Once an aperture is defined its attributes cannot be changed.

5.3.1 Aperture Attributes on Regions

Counterintuitively, aperture attributes *can* be attached to regions. When a G36/G37 creates a region all aperture attributes in the attribute dictionary at that moment are attached to it, in the same way as they would be attached to an aperture created with an AD command.

Aperture attributes on regions are necessary. Aperture attributes are a way to attach properties to objects such as draws or flashes created with that aperture. It is sometimes necessary to attach the same property to region objects, which are created without an aperture. For example, the function 'conductor' must be assigned both to tracks – draws, created with an aperture – and copper pours – regions. This is done by attaching the aperture attribute

.AperFunction, Conductor both to the track aperture and the region. Without the ability to attach aperture to regions a double set of attributes would be needed or another less elegant mechanism.

A way to view this is that the G36 command creates a virtual region aperture and attaches attributes to it in the same way as an AD does with a real aperture.

5.4 Object Attributes (TO)

An *object attribute* is attached to graphics objects. When a D01, D03 or region statement (G36/G37) creates an object all object attributes in the attribute dictionary are attached to it. As attribute commands are not allowed inside a region statement, *all* regions created by that statement have the same object attributes. Once attached to an object they cannot be changed.

The TO command adds an object attribute into the attributes dictionary. It has the same syntax as the TF command:

<TO command> = %TO<AttributeName>[,<AttributeValue>]*%

<AttributeValue> = <Field>{,<Field>}

The attribute name must follow the syntax in section 3.6.5, fields the one in 3.6.7. The name is unique and cannot be used for any other attribute, even of another type. The value of an object attribute can be modified by a new TO command with the same attribute name.



Example:

%TO.C, R6*%

5.5 Delete Attribute (TD)

The TD command deletes an attribute from the attributes dictionary. Note that the attribute remains attached to apertures and objects to which it was attached before it was deleted.

<TD command> = %TD[<AttributeName>]*%

The <AttributeName> is the name of the attribute to delete. If omitted, the whole dictionary is cleared.

5.6 Standard Attributes

5.6.1 Overview

Name	Usage	Section	Attached to
.Part	Identifies the part the file represents, e.g. a single PCB	5.6.2	File
.FileFunction	Identifies the file's function in the PCB, e.g. top copper layer	5.6.3	File
.FilePolarity	Defines whether the file represents the presence or absence of material in the PCB layer, expressed by positive or negative	5.6.4	File
.SameCoordinates	All files in a fabrication data set with this attribute use the same coordinates. In other words, they align.	5.6.5	File
.CreationDate	Defines the creation date and time of the file.	5.6.6	File
.GenerationSoftware	Identifies the software creating the file.	5.6.7	File
.ProjectId	Defines project and revisions.	5.6.8	File
.MD5	Sets the MD5 file signature or checksum.	5.6.9	File
.AperFunction	Function objects created with the apertures, e.g. SMD pad	5.6.10	Aperture
.DrillTolerance	Tolerance of drill holes	5.6.11	Aperture
.FlashText	If a flash represents text allows to define string, font, ...	5.6.12	Aperture
.N	The CAD net name of a conducting object, e.g. Clk13.	5.6.13	Graphics Object
.P	The pin number (or name) and reference descriptor of a component pad on an outer layer, e.g. IC3,7.	5.6.14	Graphics Object
.C	The component reference designator linked to an object, e.g C2.	5.6.15	Graphics Object

Table with the standard attributes

Attributes are not needed when the image only needs to be rendered. However, attributes are needed in PCB fabrication data, when transferring PCB data from design to fabrication. For example, the fabricator needs to know what are the via pads to handle the solder mask properly. The standard attributes transfer the design intent from CAD to CAM in an unequivocal and standardized manner. This is sometimes rather grandly called “adding intelligence to the image”. Without standard attributes the design intent must be gathered from various documents,

unwritten rules, conversations or reverse engineering, with all the risks of error and delay that this entails.

It is strongly recommended to use standard attributes as comprehensively as possible. If you cannot provide *all* the attributes or are unsure of their use then provide all the attributes you are comfortable with. Partial information is better than no information. For professional PCB production the bare minimum is to set .FileFunction and .FilePolarity.

Note that standard attribute values typically contain a value “Other” to cater to requirements not yet foreseen in the specification. The intention is to add new values as the need arises to reduce the use of “Other” over time.

If a user has a need for standard meta-information for which there is no attribute name or attribute value please contact Ucamco at gerber@ucamco.com to request it. Authors will be properly acknowledged when their suggestions are included in the standard.



Warning: Do not invent your own standard attribute names (names starting with a dot). This would defeat the purpose of standardization. User attributes cater to specific needs that are not covered by the standard attributes. Feel free to invent any user attribute you wish.

5.6.2 .Part

The value of the .Part file attribute identifies which part is described. The attribute – if present - must be defined in the header.

.Part value	Usage
Single	Single PCB
Array	A.k.a. customer panel, assembly panel, shipping panel, biscuit
FabricationPanel	A.k.a. working panel, production panel
Coupon	A test coupon
Other, <mandatory field>	None of the above. The mandatory field informally indicates the part

.Part file attribute values



Example:

```
%TF.Part,Array*%
```

5.6.3 .FileFunction

The .FileFunction file attribute identifies the function of the file in the PCB layer structure. Of all the attributes it is the most important.

 **Example:**

```
%TF.FileFunction,Copper,L1,Top*%
```

The attribute must be defined in the header.

The existence of a file function does not mean that it must be included in each PCB fabrication data sets. Include the files that are needed: no more, no less.

The file functions are designed to support all file types in current use. If a type you need is missing please contact us at gerber@ucamco.com.

.FileFunction value	Usage
Data files	
<code>Copper,L<p>, (Top Inr Bot) [, <type>]</code>	<p>A conductor or copper layer.</p> <p>L<p> (p is an integer>0) specifies the physical copper layer number. Numbers are consecutive. The top layer is always L1. (L0 does <i>not</i> exist.) The mandatory field (<i>Top Inr Bot</i>) specifies it as the top, an inner or the bottom layer; this redundant information helps in handling partial data. The specification of the top layer is "Copper,L1,Top[, type]", of the bottom layer of an 8 layer job it is <code>Copper,L8,Bot[, type]</code></p> <p>The top side is the one with the through-hole components, if any.</p> <p>The optional <type> field indicates the layer type. If present it must take one of the following values: <i>Plane, Signal, Mixed</i> or <i>Hatched</i>.</p>
<code>Plated,i,j, (PTH Blind Buried) [, <label>]</code>	<p>Plated drill/rout data, span from copper layer i to layer j. The from/to order is not significant. The (PTH Blind Buried) field is mandatory.</p> <p>The label is optional. If present it must take one of the following values: <i>Drill, Rout</i> or <i>Mixed</i>.</p>
<code>NonPlated,i,j, (NPTH Blind Buried) [, <label>]</code>	<p>Non-plated drill/rout data, span from copper layer i to layer j. The from/to order is not significant. The (NPTH Blind Buried) field is mandatory.</p> <p>The label is optional. If present it must take one of the following values: <i>Drill, Rout</i> or <i>Mixed</i>.</p>

.FileFunction value	Usage
Profile, (P NP)	<p>A file containing the board profile (or outline) and only the board profile. Such a file is mandatory in a PCB fabrication data set. See 5.8.1.</p> <p>The mandatory (P NP) label indicates whether board is edge-plated or not.</p>
Soldermask, (Top Bot) [, <index>]	<p>Solder mask or solder resist.</p> <p>Usually the image represents the solder mask <i>openings</i>; it then has negative polarity, see 5.6.4.</p> <p>The optional field is only needed when there is more than one solder mask on one side – top or bottom. The integer <index> then numbers the solder masks from the PCB side outwards, starting with 1 for the mask directly on the copper. Usually there is only one solder mask on a side, and then <index> is omitted. An example with two top solder masks:</p> <p>Soldermask, Top, 1 ← Mask on the copper Soldermask, Top, 2 ← Mask on the first mask</p>
Legend, (Top Bot) [, <index>]	<p>A legend is printed on top of the solder mask to show which component goes where. A.k.a. ‘silk’ or ‘silkscreen’.</p> <p>See the Soldermask entry for an explanation of the index.</p>
Paste, (Top Bot)	Locations where paste must be applied.
Glue, (Top Bot)	Glue spots used to fix components to the board prior to soldering.
Carbonmask, (Top Bot) [, <index>]	See Soldermask for the usage of <index>.
Goldmask, (Top Bot) [, <index>]	See Soldermask for the usage of <index>.
Heatsinkmask, (Top Bot) [, <index>]	See Soldermask for the usage of <index>.
Peelablemask, (Top Bot) [, <index>]	See Soldermask for the usage of <index>.
Silvermask, (Top Bot) [, <index>]	See Soldermask for the usage of <index>.
Tinmask, (Top Bot) [, <index>]	See Soldermask for the usage of <index>.
Depthrout, (Top Bot)	Area that must be routed to a given depth rather than going through the whole board.

.FileFunction value	Usage
Vcut[, (Top Bot)]	Contains the lines that must be v-cut. (V-cutting is also called scoring.) If the optional attachment (Top Bot) is not present the scoring lines are identical on top and bottom – this is the normal case. In the exceptional case scoring is different on top and bottom two files must be supplied, one with Top and the other with Bot.
Viafill	Contains the via's that must be filled. It is however recommended to specify the filled via's with the optional field in the .AperFunction ViaDrill.
Drawing files	
ArrayDrawing	A drawing of the array (biscuit, assembly panel, shipment panel, customer panel).
AssemblyDrawing, (Top Bot)	A drawing with the locations and reference designators of the components. It is mainly used in PCB assembly.
Drillmap	A drawing with the locations of the drilled holes. It often also contains the hole sizes, tolerances and plated/non-plated info.
FabricationDrawing	A drawing with additional information for the fabrication of the bare PCB: the location of holes and slots, the board outline, sizes and tolerances, layer stack, material, finish choice, etc.
Vcutmap	A drawing with v-cut or scoring information.
OtherDrawing, <mandatory field>	Any other drawing than the 4 ones above. The mandatory field informally describes its topic.

Other files	
Pads, (Top Bot)	A file containing only the pads (SMD, BGA, component, ...). Not needed in a fabrication data set.
Other, <mandatory field>	<p>The value 'Other' is to be used if none of the values above fits. By putting 'Other' rather than simply omitting the file function attribute it is clear the file has none of the standard functions, already useful information. Do not abuse standard values for a file with a vaguely similar function – use 'Other' to keep the function value clean and reliable.</p> <p>The mandatory field informally describes the file function.</p>

.FileFunction attribute values



Examples. File functions of a four layer board (One for each Gerber file):

```
%TF.FileFunction, Legend, Top*%
%TF.FileFunction, Soldermask, Top*%
%TF.FileFunction, Copper, L1, Top*%
%TF.FileFunction, Copper, L2, Inr, Plane*%
%TF.FileFunction, Copper, L3, Inr, Plane*%
%TF.FileFunction, Copper, L4, Bot*%
%TF.FileFunction, Soldermask, Bot*%
%TF.FileFunction, NonPlated, 1, 4, NPTH, Drill*%
%TF.FileFunction, NonPlatd, 1, 4, NPTH, Rout*%
%TF.FileFunction, Plated, 1, 4, PTH*%
%TF.FileFunction, Profile, NP*%
%TF.FileFunction, Drillmap*%
%TF.FileFunction, Drawing, Stackup*%
```

5.6.4 .FilePolarity

The .FilePolarity specifies whether the image represents the *presence or absence* of material.

The .FilePolarity attribute does *not* change the image - no attribute does. It changes the interpretation of the image. For example, in a copper layer in positive polarity a round flash generates a copper *pad*. In a copper layer in negative polarity it generates a *clearance*.

The attribute must be defined in the header.

 **Warning:** Solder mask images nearly always represent the solder mask *openings* and are therefore *negative*. This may be counter-intuitive.

Drill and rout files represent the removed material. Drill files are therefore positive, as is intuitive.

.FilePolarity value	Usage
Positive	The image represents the <i>presence</i> of material (recommended)
Negative	The image represents the <i>absence</i> of material

.FilePolarity attribute values

 **Example:**

```
%TF.FileFunction,Copper,L2,Inr,Plane*%
%TF.FilePolarity,Positive*%
```

 **Note:** It is recommended output copper layers in positive. Power/ground planes in negative was introduced in the 1970s and 1980s to get around the limitations in the vector photoplotters then used. There no longer any reason to use them, and they have a problem: they cannot not define how close the copper gets to the outline of the PCB. See 4.12.5 in how to create power/ground planes in positive. But if you need to output negative copper layers, make it clear they are negative by setting the .FilePolarity attribute.

5.6.5 .SameCoordinates

All layers in a PCB fabrication data set- a folder or archive - must use the same coordinate system. In other words, they must align or register as the layers in the physical PCB do. For example, the pads, drill holes, pads and solder mask openings of a pad stack must all have the same coordinates.

Layers must not be offset, mirrored or flipped versus one another. This may seem obvious but unfortunately in 1/3 of the data sets layers do not align. The fabricator consequently cannot trust the alignment of the incoming data. This uncertainty interferes with fast and automatic processing; worse, it can lead to scrap with boards where wrong alignment is not obvious, such as very symmetric HF boards.

The .SameCoordinates attribute allows CAD to inform the fabricator that the alignment is correct and instruct him to use the alignment in the data.

The attribute must be defined in the header. The syntax is as follows:

```
%TF.SameCoordinates[,<ident>]*%
```



Example – without ident:

```
%TF.SameCoordinates*%
```

If in a PCB fabrication data set this attribute is present in a number of Gerber files then they are in alignment with each other.



Example – with a GUID as ident:

```
%TF.SameCoordinates,f81d4fae-7dec-11d0-a765-00a0c91e6bf6*%
```

The ident is optional. Its purpose is the following. There may be situations where files in the fabrication data are output at different times, with different coordinate systems. In that situation simply outputting the attribute would wrongly signal the layers do align. Adding the ident avoids this error by distinguish between these different coordinate systems at output time. If the attribute with the same ident is present in a number of Gerber files then they align. If the ident is different they may not align – which would be an error because all files must align. For the fabricator the only important fact is whether the ident, if present, are identical or not; otherwise the ident has no meaning. A very safe ident is a GUID. When all files are output at the same time, with the same coordinates, the ident is not needed.

Note that anyhow all data files must align, attribute or no attribute, ident or not.

5.6.6 .CreationDate

The .CreationDate file attribute identifies the moment of creation of the Gerber file.

The attribute – if present - must be defined in the header. The attribute value must conform to the full version of the ISO 8601 date and time format, including the time and time zone. A formally defined creation date can be helpful in tracking revisions – see also 5.6.8



Example:

```
%TF.CreationDate,2015-02-23T15:59:51+01:00*%
```

5.6.7 .GenerationSoftware

The .GenerationSoftware file attribute identifies the software that generated the Gerber file.

The attribute – if present - must be defined in the header. The syntax is as follows:

```
%TF.GenerationSoftware,<vendor>,<application>[,<version>]*%
```



Example:

```
%TF.GenerationSoftware,Ucamco,UcamX,2017.04*%
```

5.6.8 .ProjectId

Usually a Gerber file is part of a PCB project with a sequence of revisions. It is important to be able to determine if different files belong to the same revision of a project, different revisions of the same project or completely different projects. This is the purpose of the .ProjectId file attribute. It uniquely identifies project and revision.

The attribute – if present - must be defined in the header. The syntax is as follows:

```
%TF.ProjectId,<Name>,<GUID>,<Revision>*%
```

The field <Name> is id or reference used by the design owner, <GUID> defines the project using a global unique ID and <Revision> specifies its revision. All parameters must conform to the string syntax, with the additional restriction that the ‘,’ character cannot be used. The <GUID> must be a string representation of a UUID conforming to RFC4122 version 1 or version 4.



Examples:

```
%TF.ProjectId,My PCB,f81d4fae-7dec-11d0-a765-00a0c91e6bf6,2*%
```

```
%TF.ProjectId,project#8,68753a44-4D6F-1226-9C60-0050E4C00067,/main/18*%
```

5.6.9 .MD5

The .MD5 file attribute sets a file signature (checksum, hash, digest) that uniquely identifies the file and provides a high degree of security against accidental modifications.

The .MD5 checksum is not intended for CAD to CAM data transfer which is probably sufficiently protected by the checksum of the zip, but rather for individual files used within fabrication, with a bewildering collection of legacy systems and protocols, and where file transmission errors sometimes occur.

The 128 bit signature is calculated with the MD5 algorithm and expressed as a 32 digit hexadecimal number (see 3.6.4). The signature is calculated over the bits from the beginning of the file up to but excluding the .MD5 file attribute command. Note that this excludes the closing M02*. The complete .MD5 file attribute command, with both '%' and '*', is excluded. Any CR and LF are excluded from signature calculation. As CR and LF do not affect the interpretation of the file but may be altered when moving platforms excluding them makes the signature portable without sacrificing security.

The signature, if present, must be put at the end of the file, just before the closing M02*. Thus the file can be processed in a single pass.



Example:

Consider the following Gerber file segment, without checksum:

```
...
D11*
X1500000Y2875000D03*
X2000000D03*
D19*
X2875000Y2875000D03*
M02*
```

As the CR and LF characters are skipped the checksum is taken over the following data:

```
...D11*X1500000Y2875000D03*X2000000D03*D19*X2875000Y2875000D03*
```

With the checksum the file then becomes:

```
...
D11*
X1500000Y2875000D03*
X2000000D03*
D19*
X2875000Y2875000D03*
%TF.MD5,6ab9e892830469cdf7e3e346331d404*%
M02*
```

<- Excluded from the MD5

<- Excluded from the MD5

The following Perl script specifies precisely how the .MD5 is calculated:

```
#script expects one parameter (original Gerber X2 file)
use Digest::MD5;

local $_ = shift;
local *IN;
my $content;

local $/;
open(IN, "<$_") or die "Cannot open $_ due to $!";
$content = <IN>;          #read file to the variable
close IN;
$content =~ s/\r|\n//g; #remove all CRLF (end of line) characters
$content =~ s/M02\*//;  #remove M02 from the end of file

#calculate MD5
$md5 = Digest::MD5->new; #init MD5
$md5->add($content);     #send content of the file to MD5 engine

print "Add 2 following lines to the Gerber file, please.\n";
print "%TF.MD5,";
print $md5->hexdigest;  #print correct MD5 hash
print "*%\nM02*\n\n";
```

5.6.10 .AperFunction

The .AperFunction aperture attribute defines the *function* or purpose of an aperture, or rather the graphics objects created with it. PCB CAM needs to know the function of graphics objects, especially pads. If this is not possible define the function of all attributes then at least define if for those where you can - partial information is better than no information. The bare minimum is to identify via pads: the PCB fabricator must know where the via pads are.

One function, one aperture. Objects with different functions must have different apertures, even if they are of the same shape and size. Apertures with multiple functions are devilishly hard to handle in CAM to start with: the CAM operator can no longer perform functions per aperture, but must check each individual hole. Furthermore, their functions cannot be identified by an aperture attribute: *all* objects created with it have the same function. This also applies to drill tools: e.g. if the same diameter is used for component holes and via holes, these still must be separate apertures. It is recommended to also use different apertures for drill holes and rout slots.

Regions. Counterintuitively, regions can carry aperture attributes, see 5.3.1. Use .AperFunction to define the function of the regions.

Painting (aka vector-fill).

It is strongly recommended not to use painting, see 7.7 . If you still construct objects by painting, the function of the painted object is set by the function of apertures used for painting. For example, if aperture 21 is used to paint SMD pads then the function of aperture 21 is SMDPad. If aperture 50 is used to paint a conductive region then the function of aperture 50 is conductor.

The .AperFunction values are defined in the tables below. Note that the attribute values typically can only be applied to specific layers - for example, an SMD pad can only be defined on an outer copper layer.

Drill and rout files	
Note that these values can apply to drill holes and rout slots.	
.AperFunction value	Usage
ViaDrill[, Filled NotFilled]	A via hole. This is reserved for holes whose <i>sole</i> function is to connect different layers. It is not to be used for holes for component leads. An optional field Filled NotFilled.
BackDrill	A hole to remove plating over a sub-span by drilling that sub-span with a larger diameter.
ComponentDrill [, PressFit]	A hole for a through-hole component leads. The optional label PressFit indicates that the drill holes are intended for press fit component leads. Press fit leads are pressed in properly sized plated-through holes to realize the electrical contact. The label can only be applied on PTH holes. See also ComponentPad.

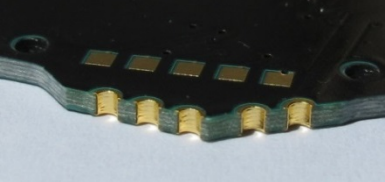
<p>MechanicalDrill [, (Tooling Breakout Other)]</p>	<p>A hole with mechanical function (registration, screw, etc.) The specifier is optional. If present it can take one of the following values:</p> <ul style="list-style-type: none"> • Tooling: Tooling holes to attach the board or panel temporarily to test fixtures during assembly and test. Also called mounting holes. • BreakOut: Non-plated holes forming a break-out tab used in break routing.  <ul style="list-style-type: none"> • Other <p>Example: .AperFunction,MechanicalDrill,Breakout .AperFunction,MechanicalDrill</p>
<p>CastellatedDrill</p>	<p>Plated holes cut- through by the board edge; used to join PCBs.</p>  <p>Image courtesy Eurocircuits.</p>
<p>OtherDrill,<mandatory field></p>	<p>A hole, but none of the above. The mandatory field informally describes the type.</p>
<p>The values in All layers can also be used</p>	

Copper layers	
.AperFunction value	Usage
ComponentPad	<p>A pad associated with a <i>through-hole component lead</i>. The pads around a ComponentDrill <i>on all layers</i> take the value ComponentPad although indeed on inner layers they only have a via function. In other words, the pad attribute value follows the drill tool attribute value.</p> <p>Only for through-hole components; SMD and BGA which have their own dedicated type.</p> <p>See also ComponentDrill.</p>
SMDPad, (CuDef SMDef)	<p>A pad belonging to the footprint of an <i>SMD component</i>. They are pasted or otherwise electrically connected to the PCB. The purpose of these pads is normally to connect the component circuitry to the PCB but for specific components some pads may not connected to the component inside the package. Excludes BGA pads which have their own type. This function is valid only for the normal electrical pads, thermal pads have their own function; see HeatsinkPad.</p> <p>The specifier (CuDef SMDef) is <i>mandatory</i>. CuDef stands for <i>copper defined</i>; it is by far the most common SMD pad; the copper pad is completely free of solder mask; the area to be covered by solder paste is defined by the copper pad. SMDef stand for <i>solder mask defined</i>; the solder mask overlaps the copper pad; the area to be covered by solder paste is defined by the solder mask opening and not by the copper pad. (CuDef is sometimes rather awkwardly called <i>non solder mask defined</i>.)</p> <p>Only applicable for outer layers.</p> <p>When an SMD pad contains a via hole the pad where the SMD is soldered, on the outer layer with the SMD, is SMDPad, all other pads in the stack are ViaPad. If the SMD pad contains an embedded via pad, as it should, then that embedded pad is of course ViaPad.</p>

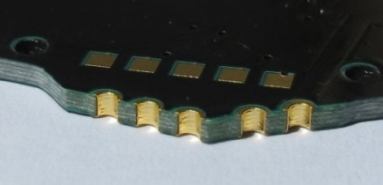
<p>BGAPad, (CuDef SMDef)</p>	<p>A pad belonging to the footprint of an <i>BGA component</i>. They are soldered or otherwise electrically connected to the PCB. The purpose of these pads is normally to connect the component circuitry to the PCB but for specific components some pads may not connected to the component inside the package.</p> <p>The specifier (CuDef SMDef) is <i>mandatory</i>. CuDef stands for <i>copper defined</i>, SMDef for <i>solder mask defined</i>; see SMDPad.</p> <p>Only applicable for outer layers.</p> <p>When a BGA pad contains a via hole the pad where the BGA is soldered is BGAPad, all other pads in the stack are ViaPad. If the BGA pad contains an embedded via pad, as it should, then that embedded pad is of course ViaPad.</p>
<p>ConnectorPad</p>	<p>An <i>edge connector</i> pad.</p> <p>Only applicable for outer layers.</p>
<p>HeatsinkPad</p>	<p>Heat sink or thermal pad, typically for SMDs</p>
<p>ViaPad</p>	<p>A via pad. It provides a ring to attach the plating in the barrel. This is reserved for pads that have <i>no other function</i> than making the connection between layers: Component pads often also have a via function; however their main function is component pad and they must have this function; similar for test pads, via in BGA etc.</p>
<p>TestPad</p>	<p>A test pad. Only applicable for outer layers.</p> <p>Sometimes a test pad is drilled and also has a via function, to save space. Such a pad <i>must</i> be specified as test pad. (It is clear from the construction that it has a via function, but the fabricator must know it is a test pad, and this is not obvious. Similarly, a component pad can also function as a via, but it remains a component pad.)</p>
<p>CastellatedPad</p>	<p>Pads on plated holes cut- through by the board edge; used to join PCBs.</p>  <p>Image courtesy Eurocircuits.</p>
<p>FiducialPad, (Global Local)</p>	<p>A fiducial pad. The specifier (Global Local) is <i>mandatory</i>.</p> <p>Local refers to a component fiducial; Global refers to a fiducial on the entire image or PCB.</p>

ThermalReliefPad	A thermal relief pad connected to the surrounding copper while restricting heat flow.
WasherPad	A pad around a non-plated hole without electrical function. Several applications, e.g. a pad that strengthens the PCB where fixed with a bolt – hence the name washer.
AntiPad	A pad with clearing polarity (LPC) creating a clearance in a plane. It makes room for a drill pass without connecting to the plane. Note that setting the AntiPad attribute itself has no effect on the image, and therefore does not turn the pad into LPC as a side effect– this must be done explicitly by an %LPC*% command.
OtherPad, <mandatory field>	A pad not specified above. The mandatory field informally describes the type.
Conductor	Copper whose function is to connect pads or to provide shielding, typically tracks and copper pours such as power and ground planes. Note that conductive copper pours should carry this attribute, whether made properly by a region statement or by painting – see Regions . (Note that painting is very poor practice, but if you have to use it, at least add the attribute so that it is clear what the tangle of draws mean.)
EtchedComponent	Etched components are embedded inductors, transformers and capacitors which are etched into the PCB copper. The following illustration shows two etched inductors:  For the CAD netlist these are components like others: the net names are different on both sides. (However, for bare-board electrical test they may be conducting copper and connect the net on both sides.)
NonConductor	Copper that does not serve as a conductor; typically text and graphics without electrical function. This value can only be applied to copper that is part of the PCB, not to drawing elements; see NonMaterial
CopperBalancing	Copper pattern added to balance copper coverage for the plating process.

Border	The copper border of a production panel.
OtherCopper, <mandatory field>	Indicates another function. The mandatory field informally describes the type.
The values in All layers can also be used	

All layers	
The values in this table can be used on all layers, <i>including</i> plated, non-plated and copper.	
.AperFunction value	Usage
Profile	Identifies the draws and arcs that exactly define the profile or outline of the PCB. This is the content of the Profile file but can also be present in other layers. See 5.8.1
NonMaterial	NonMaterial can occur on files that define the pattern of material layers of a PCB such as copper layers or solder mask. Sometimes such files not only contains data representing material but also drawing elements such as a frame and a title block. The attribute value NonMaterial identifies objects that do not represent material. (Note: Such objects that should not be there at all, see 5.8.3).
Material	Identifies the proper part of the data file. Solder masks are traditionally negative. The image represents the solder mask openings. The apertures take the value 'Material' – they define solder mask material, but in a negative way. For copper and drill layers Material is split into more specific functions such as SMD pad. Use the specific functions when available rather than 'Material'.
Other, <mandatory field>	The value 'Other' is to be used if none of the values above fits. By putting the value 'Other' rather than crudely omitting the attribute it is made explicit that the value is none of the above – an omitted attribute can be one of the above. Certainly do not abuse existing values by horseshoeing an attribute with a vaguely similar function into that value that does not fit perfectly – keep the identification clean by using 'Other'. The mandatory field informally describes the aperture function.

.AperFunction aperture attribute values

Functions on extra layers. The solder mask, paste and other extra layers openings *cannot* take the pad values. Pad values are reserved for outer copper layers. The solder mask openings and paste pads take their function from the underlying copper pads. The reason for this is that a single solder mask opening may have multiple underlying copper pads – e.g. an SMP pad with an embedded via pad - and hence multiple functions.

Consequently, solder mask openings have the aperture function 'Material'. Admittedly this is somewhat a misnomer in this context as solder masks are usually negative, and the presence of image indicates therefore the absence of material; this has nothing to do with the pad functions but with the layer being negative.

The following file creates a circular hole in the solder mask. In negative file polarity the image represents the absence of material.

```
%FSLAX26Y26*%  
%MOIN*%  
%TF.FileFunction,Soldermask,Top*%  
%TF.Part,Single*%  
%TF.FilePolarity,Negative*%  
%TA.AperFunction,Material*%  
%ADD10C,0.070*%  
%LPD*%  
D10*  
X1235000Y0012500D03*  
...  
M02*
```

If the file polarity is positive an otherwise identical file creates a circle consisting of solder mask.

```
%FSLAX26Y26*%  
%MOIN*%  
%TF.FileFunction,Soldermask,Top*%  
%TF.Part,Single*%  
%TF.FilePolarity,Positive*%  
%TA.AperFunction,Material*%  
%ADD10C,0.070*%  
%LPD*%  
D10*  
X1235000Y0012500D03*  
...  
M02*
```

5.6.11 .DrillTolerance

.DrillTolerance defines the plus and minus tolerance of a drill hole end diameter. Both values are positive decimals expressed in the MO units. The attribute value has the following syntax:

<plus tolerance>,<minus tolerance>



Examples:

%TA.DrillTolerance,0.01,0.005*%

5.6.12 .FlashText

Gerber intentionally does not contain fonts or typographic text – this would introduce a complexity out of proportion to its benefits. Any text can be represented with the available graphic constructs, especially with contours. However, such generic graphic constructs do not maintain the information which text string is represented; this is sometimes a disadvantage.

The .FlashText aperture attribute transfers this otherwise lost information. .FlashText is designed for text image created with a flash. If the text is created with draws and arcs rather than a flash, it can always be flashed by collecting them in a block aperture.

Bar codes are handled as text – one can view a barcode as a special font.

Syntax and semantic of follows:



the attribute value is as

<Text>,(B|C),[(R|M)],[],[<Size>],[<Comment>]

.FlashText fields	Usage
<text>	The text string represented by the aperture image.
(B C)	Indicates if the text is represented by a <i>barcode</i> – B -or by <i>characters</i> - C.
(R M)	Indicates if the text is readable or mirrored left-right . Optional.
	Font name. Content not standardized. Optional.
<Size>	Font size. Content not standardized. Optional.
<Comments>	Any extra information one wants to add. Optional.

An empty field means that the corresponding meta-data is not specified.

Examples:

%TA.FlashText,L1,C,R,Courier,10,Layer number (L1 is top)%

Text: L1
 B|C: Characters,
 (R|M): Readable
 Font: Courier
 Size: 10

Comment: Layer number (L1 is top)

```
%TA.FlashText,XZ12ADF,B,,Code128,,Project identifier *%
```

```
Text:      XZ12ADF
B|C:      Barcode
(R|M)     Not specified
Font:     Code128
Size:     Not specified
Comment:  Project identifier
```

5.6.13 .N (Net)

The .N object attribute attaches a CAD netlist name to any conducting object. The attribute can be attached to objects on any copper layer or plated drill/rout file. It indicates the object is part of the given net. The .N attribute is intended to allow quick visualization of nets and, more importantly, to define the CAD netlist.

Normally an object is fully connected and consequently belongs to a single net. However, if an object consists of different disconnected parts or is split in several disconnected parts by clear (LPC) objects it may belong to different nets. Then the .N attribute value must include all net names involved. It is recommended to avoid creating disconnected objects: one object, one net.

The syntax is:

<.N Attribute> = .N,<netname>{,<netname>}

.N field	Usage
<netname>	The CAD net name. It can take any value conforming to the field syntax.



Example:

```
%TA.aperFunction,Conductor*%
%ADD21C,1*%           Create aperture 21, for conductive tracks
...
D21*                 Select aperture 21
%TO.N,Clk3*%         Select net Clk3
X5600000Y1200000D02* Move to the start of a track
X5600000Y1202500D01* Draw the tracks with Clk3 is attached
X5605000Y1205000D01*
X5605000Y1220000D01*
...
```

There are two reserved net names:

- 1) The empty string, defined by %TO.N,*% identifies objects not connected to a net, such as tooling holes, text, logos, pads for component leads not connected to the component circuitry.
- 2) The name N/C, defined by %TO.N,N/C*%, identifies a single pad net, as an alternative to giving each such net a unique name.

Except the reserved names all net names must be unique.

It is recommended to attach a .N attribute to all copper objects, also those without net. The absence of the .N attribute does not mean there is no net; the absence is therefore ambiguous.

Normally an object is fully connected and consequently belongs to a single net. However, if an object consists of different disconnected parts or is split in several disconnected parts by clear (LPC) objects it may belong to different nets. Then the .N attribute value must include all net names involved. It is recommended to avoid creating disconnected objects: one object, one net.

5.6.13.1 Etched Components

Etched components are embedded inductors, transformers and capacitors which are etched into the PCB copper. The following illustration shows two etched inductors.



They are identified by the .AperFunction attribute value 'EtchedComponent' on to the aperture used to create them. See [EtchedComponent](#).

For the CAD netlist these are components like others: the net names are different on both sides. (However, for bare-board electrical test they may be conducting copper and simply connect the nets on both sides.)

Etched components do not need and normally do not have pads. There is no .P associated with them. The net on each side is different however.

5.6.14 .P (Pin)

The .P object attribute attaches the reference descriptor and pin number of a component pin to a pad. The syntax is:

<.P Attribute> = .P,<component>,<number>[,<function>]

.P fields	Usage
<component>	The component reference descriptor. It can take any value conforming to the field syntax.
<number>	The pin number. It can take any value conforming to the field syntax. It is normally simply a number.
<function>	The pin function. It can take any value conforming to the field syntax. It is optional because it is not needed for the netlist, but it contains useful information.



Example, for netlist only:

```
D13*                               Select aperture 13 for the pads for R5
%TO.P,R5,1*%
X5600000Y1200000D03*              The pad for R5, pin 1
%TO.P,R5,2*%
X5600000Y1202500D03*              The pad for R5, pin 2
```



Example, with pin function:

Take the following integrated circuit:

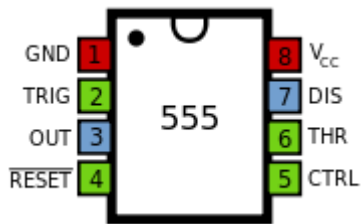

The pin attributes could be as follows:

```
D13*                               Select aperture 13 for the pads for IC12
%TO.P,IC12,1,GND*%
X5600000Y1200000D03*
%TO.P,IC12,2,TRIG*%
X5600000Y1202500D03*
...
```

The .P attribute can be attached to any pad belonging to a component and only those. The pin number must be a non-empty field, with one exception: if the pad is part of the component footprint but not connected to the component circuitry the name may be an empty field, e.g. defined by `%TO.P,U3,*%`; pads with an empty name are normally not part of a net and therefore also have an empty net name attached defined by `%TO.N,*%`.

Consequently, it can only be used in copper layers that carry the components. Typically, these are the outer layers and then the .P attribute can only be used in the outer layers. Embedded or etched components can be on inner layers and then these inner layers can also carry the .P attribute.

A single component pad can consist of multiple flashes. Each flash then carries the same reference descriptor and pin number.

It is technically possible to create a single object representing multiple pads. For example, a single macro aperture can describe a complete component footprint. This is possible but *not allowed*. (It would be a neat way to make life miserable for CAM engineers though.)

The .P attribute can be attached to *flashed pads only*, not to painted pads.

5.6.15 .C (Component)

The .C object attribute attaches the component reference descriptor of a component to an object. It indicates that the object belongs to the given component. The attribute can be attached to objects on any layer. It is intended to identify e.g. which objects on a legend belong to which components.

The syntax is:

<.C Attribute> = .C,<RefDes>

.C field	Usage
<RefDes>	The component reference descriptor. It can take any value conforming to the field syntax.



Example in a legend layer:

D21*	Select aperture 21, used for component symbols
%TO.C,R2*%	Select reference descriptor R2
X5600000Y1200000D02*	Move to the start of the symbol
X5600000Y1202500D01*	Draw the symbol
X5605000Y1205000D01*	
X5605000Y1220000D01*	
...	

The attribute .C,R2 is attached to all tracks drawing the resistor symbol.

5.7 Text in the Image

Gerber has no native font support – this adds too much complication in relation to the modest text requirements in PCB fabrication data. Text must be represented as pure image data, best as regions (contours), see 4.12.

Font definitions often contain splines and Gerber does has linear and circular segments but no splines. The splines must therefore be approximated to either linear or circular segments. Circular is more precise with less objects than linear, but mathematically more complicated.

An issue with representing text as image is that the information is lost that this image is text, and which string it represents. This is easily solved with the attributes `.AperFunction` (5.6.4.1) and `.FlashText` (5.6.4.3). (It may be counterintuitive, but these aperture attributes can be associated with regions; see 5.3, attributes on regions.) An example; suppose one needs to add the text 'Intercept' on the bottom copper layer. Here is how it goes:

```
%TA.AperFunction,NonConductor*%    <- Indicates the copper is not a conductor,
                                     typically text and graphics
%TA.Flashtext,Intercept,C,M*%      <- Indicates the copper represents the string
                                     'Intercept', as characters and mirrored
G36*
...
G37*
%TD.AperFunction*%                 <- Deletes the attribute
%TD.FlashText*%                    <- Deletes the attribute
```

5.8 PCB Fabrication Data

5.8.1 Structure

PCB Fabrication data is a set of Gerber files and possibly files in other portable formats such as PDF. The files can either be in a directory or combined in a zip file. (Other archive formats such as rar, 7z are not allowed.)

5.8.2 Alignment

All data files in a fabrication data set must be scaled 1/1 and align perfectly – same offset, no mirroring, seen from the top to bottom.

5.8.3 Essential Attributes

A single Gerber file defines a single layer image. A PCB, however, is not a set of independent layers. To define the complete PCB image one must not only define the individual layer images but also their position in the layer structure. This is done with the file attributes `.FileFunction` and `.FilePolarity`. Considering the complete PCB these attributes are not meta-information but image definition data without which the PCB image is not fully defined. These two attributes can be viewed as mandatory in PCB fabrication data.

5.8.1 The Profile

The profile defines the physical extent or the area covered by the PCB. An area is described by its contour (see 4.12.1) in the Gerber format. A fabrication data set must contain a separate file with the profile, defined by a contour (G36/G37). This file is identified by the file function value Profile,(P|NP).

Normally a profile will not have holes. Slots are part of the PCB and are defined in the drill/rout files. A big hole that is not considered part of the PCB can be defined by a contour with a cut-in (see 4.12.3).

Sometimes one defines the profile layer by a line drawn with a small or a zero-size aperture instead of the profile. Such a line does not represent an area as defined in Gerber data but is a drawing, useful for human reading. While not correct, it is not difficult to convert it to a contour if the line is drawn accurately, obeying the same rules as for contour segments (see 4.12.3). So if for whatever reason you must represent the profile by a line ensure that the line is properly constructed. Essential is that the profile is clearly defined, in a separate file, so that it is clear it is a profile, and is not hidden in the copper layers or drawings. Corner marks are not good enough as they are only suitable for manual processing.

5.8.2 Drill files

In CAD to CAM workflows drill information can and is best represented in Gerber than in an NC format. Of course, a Gerber file cannot be sent to a drill machine, but this is not the issue here. No fabricator uses his client's incoming design files directly on his equipment. The design files are always read in a CAM system, and it is the CAM system that will output drill files in the appropriate NC format, including feeds and speeds and all the information exactly as needed by the driller. To transfer data from CAD to CAM Gerber is more suitable. As the copper, mask, drill and rout files are all image files to be read into the CAM system, it is best to use the same format for them all, thereby ensuring optimal accuracy, registration and compatibility. Mixing formats needlessly is asking for problems. Most importantly, NC formats do not have attributes.

The drill/rout file image represents the *end diameter* of the hole, after plating, aka inner diameter.

This specification does not differentiate between drilling and routing because these two admittedly distinct fabrication processes are identical from the point of view of their image descriptions: the image simply represents where material is removed. The fabricator will determine what to drill and what to rout.

Each drill span (from-to layers) must be put in a separate Gerber file. PTH and NPTH must be split in two separate files.

5.8.2.1 Backdrilling

An example explains best how to structure a job with backdrilling. Suppose we have an 8 layer job with backdrilling to remove via plating between layers 8 and 7. We need two files:

One file contains the via's. It has .FileFunction *Plated,1,8,PTH*. The drill tool has the via end diameter. Its .AperFunction value is *Via*.

The second file contains the backdrills. It has .FileFunction *NonPlated,8,7,Blind*. The drill tool has the same diameter as the via – the manufacturer will determine the tool diameter. Its .AperFunction value is *Backdrill*.

5.8.3 Drawings and Data

Gerber files in PCB fabrication data contains two types of images.

- Drawings, such as a drill map, a fabrication drawing or an assembly drawing. Such images are intended to be looked at by humans, and may contain vital fabrication instructions.
- Digital data representing the patterns of the copper, the solder mask, legend, drills. This digital data is intended to be processed by CAM software.

Unfortunately, the two are sometimes mixed, and drawing elements added to copper files etc. as in the example below.

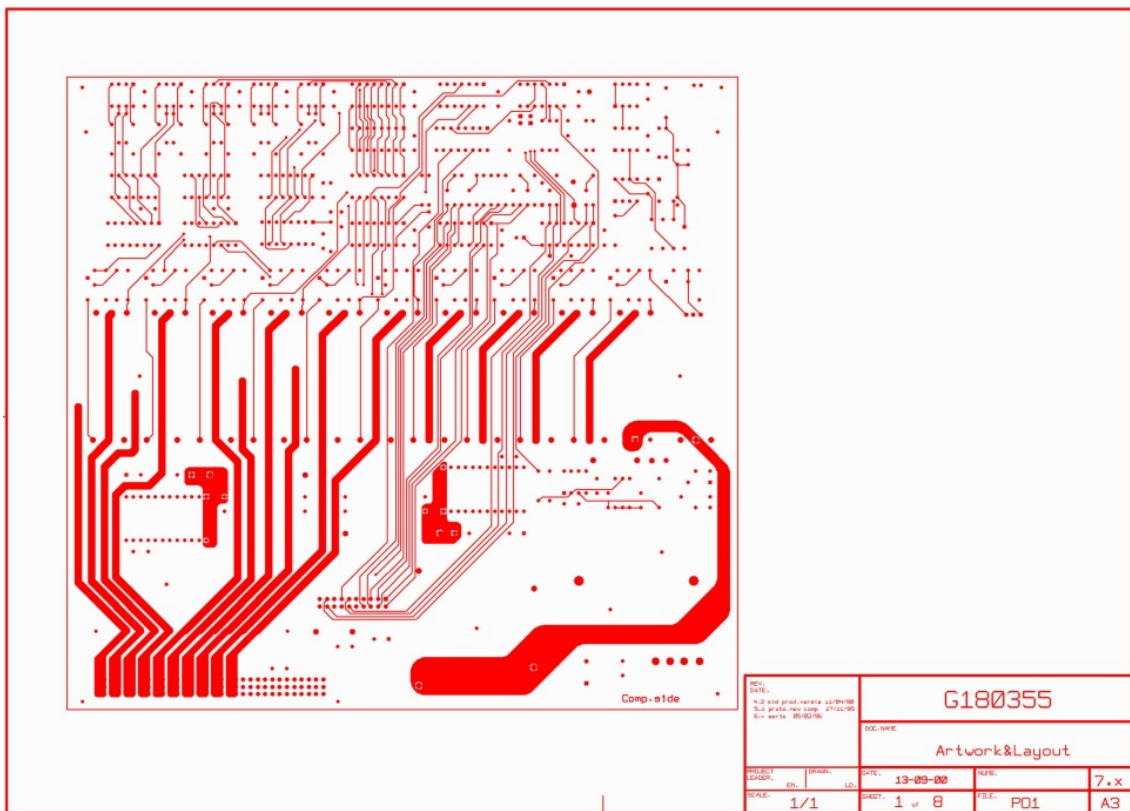

53. Confusing a drawing and digital data

Such a file is no longer machine readable. An operator must first manually remove the drawing elements. Before doing so he must check if these elements do not contain vital information and write this down somewhere for future reference. Keep data files pure. The drawings must contain all information that belongs to drawing. If need be, information that belongs to a specific file can be put in attributes. Less manual work, less risk of error. Simpler and cleaner.

5.8.4 The CAD Netlist

The CAD netlist describes which component pins are connected. Pins are identified by their component reference descriptor and pin number or name. Nets are identified by the net name. Here is an example of a CAD netlist; The first line lists all pins of net Clk3.

```
Clk3: U1-4,U2-3,U5-9,U6-9,U7-9
Sig11: U1-3,U5-12
Data8: U2-4,U5-10,U6-10,U7-8,U8-1
GND: U1-1,U2-1,U3-8,U4-16,U5-16,U6-1,U7-8,U8-8
```

...

The CAD netlist links component pads to nets. It specifies the function of the PCB and is the basis for the layout.

In Gerber the CAD netlist is defined by attaching both the pin and the net attribute to each component pad. This defines a pad - net entry in the CAD netlist, and at the same time associates a pad location and shape to it. For instance, the first entry in the CAD netlist above is given by the following sequence:

```
%TO.P,U1,4*%  
%TO.N,Clk3*%  
X...Y...D03*      The flash that creates the pad
```

...

If the .P attribute is present then the *complete* CAD netlist must be present, including all edge connectors test points and etched components. In other words, all the end points of the nets must be included, all the pads, *not only* the pads of the physical components that are part of the BOM. Although vias are part of a net, they are not component pads and cannot have a .P attached. Washer pads or any pads that are not part of an component cannot have a .P attached.

5.8.4.1 Benefits of Including the CAD Netlist.

For the assembly process the location and orientation of each component must be known. This can easily be extracted from the Gerber file.

The netlist and component names facilitate the communication between the parties involved in design and fabrication. Viewers show more complete PCB information.

More importantly, the netlist information dramatically increases the security of the design to fabrication data transfer. If the image CAM reads from a Gerber file significantly differs from the image intended by CAD, due to bugs, operator errors or transmission errors, the inevitable result is scrap. Such a difference in image results in a difference in board netlist, which can be detected by comparing the calculated board netlist with the supplied CAD netlist. The CAD netlist therefore provides a very powerful redundancy check against image errors. To be precise, the following assert must be valid:

- Interpret all N/C's as unique names
- Flashes with the same reference descriptor and pad are deemed connected
- Etched components are removed before connection is calculated
- Assert 1: pads with the same net name must be connected
- Assert 2: pads with different net names must be isolated.

Lastly, a bare board PCB fabricator is expected to perform an electrical test on the bare PCB and guarantee the PCB conforms to the CAD netlist. It then is logical to provide him with the netlist to test against. Without providing the netlist the fabricator is expected to reverse engineer the netlist and must test against a reverse engineered net – hardly a secure procedure.

5.8.4.2 IP Considerations

Net names such as Clk13 provide information about the design. This may be a concern. A solution is to replace the meaningful names with obfuscated names such a sequential number. This still allows to compare the design netlist with the image netlist as a redundancy check – meaningful names are not needed for that. The obfuscated names are a little less convenient when communicating between creator and receiver of the Gerber file, but both can still identify the same net as long as the creator can identify the net corresponding to the obfuscated name

he created. Obfuscated names are sometimes a sensible balance between IP protection and data transfer security.

It is sometimes alleged that even a net list with obfuscated names pose an IP security risk as it still shows the connections between the pads. This is an obvious fallacy as the connections between the pads can be worked out from the image. In fact, if this were not true, a fabricator would be unable to perform a bare board electrical test without netlist information.

5.9 Examples

The example below shows the usage of a simple aperture attribute.



Example:

```
G01*
%ADD13R,200X200*%           G04 this aperture has no attribute*
D13*
%TAIAmATA*%                 G04 add attribute IAmATA in attributes
                              dictionary*
X0Y0D03*                     G04 this flash object has no attribute*
%ADD11R,200X200*%           G04 this aperture now has attached attribute
                              IAmATA*
%TDIAmATA*%                 G04 delete attribute IAmATA from current
                              attributes dictionary*
%ADD12C,5*%                 G04 this aperture does not have attribute IAmATA*
D11*
X100Y0D03*                   G04 this flash object has attribute IAmATA*
X150Y50D02*
D12*
X100Y150D01*                 G04 this draw object has no attribute*
```

The next example illustrates an aperture attribute definition and changing value.



Example:

```

G01*
%TA.AperFunction,SMDPad*%      G04 Adds attribute .AperFunction in the
                                current dictionary with value SMDPad to
                                identify SMD pads*

%ADD11...*%                    G04 Aperture with D-code 11 gets the
                                .AperFunction,SMDPad attribute attached*

%TA.AperFunction,Conductor*%   G04 Changes the value of .AperFunction
                                attribute to define conductors*

%ADD20...*%                    G04 Aperture with D-code 20 gets the
                                .AperFunction,Conductor attribute attached*

%TACustAttr,val*%              G04 Adds attribute CustAttr in the current
                                attributes dictionary and sets its value to
                                val*

%ADD21...*%                    G04 Aperture with D-code 21 is a conductor
                                with attached attribute CustAttr = val*

%TD.AperFunction*%             G04 Deletes the .AperFunction attribute from
                                the attributes dictionary*

%ADD22...*%                    G04 Aperture with D-code 22 has no attached
                                .AperFunction attribute, but has attribute
                                CustAttr = val*

%TDCustAttr *%                 G04 Deletes the CustAttr attribute from the
                                attributes dictionary*

%ADD23...*%                    G04 Aperture with D-code 23 has no attached
                                aperture attributes*

...

D11*                            G04 Set current aperture to aperture 11*
X1000Y1000D03*                 G04 Flash an SMD pad*
D20*                            G04 Use aperture 20 for graphical objects &
                                attach it to regions*

X2000Y1500D01*                 G04 Draw a conductor*
%TA.AperFunction,Conductor*%   G04 Changes the value of .AperFunction
                                attribute to define conductors*

G36*                            G04 Start a conductive region. IT TAKES ON
                                THE ATTRIBUTE VALUES FROM THE DICTIONARY*

...
G37*
%TD*%                           G04 Clear attribute dictionary*
G36*                            G04 Start a region, without attributes*

...
G37*

```

6 Errors and Bad Practices

6.1 Errors

Poor implementation of the Gerber format can give rise to invalid Gerber files or – worse – valid Gerber files that do not represent the intended image. The table below lists the most common errors.

Symptom	Cause and Correct Usage
Clearances in planes disappear.	This is often the consequence of invalid cut-ins resulting in self-intersecting contours. The root cause is usually sloppy rounding aggravated by low-resolution output. <i>See 4.12.3.</i>
Rotating aperture macros using primitive 21 gives unexpected results.	Some CAD systems incorrectly assume that primitive 21 rotates around its center. This is wrong, it rotates around the origin. <i>See 4.5.4.5.</i>
Unexpected image after an aperture change or a D03.	Coordinates have been used without an explicit D01/D02/D03 operation code. This practice is deprecated because it leads to confusion about which operation code to use. Coordinate date must always be combined with an explicit D01/D02/D03 operation code. <i>See 7.2.</i>
Objects unexpectedly appear or disappear under holes in standard apertures.	Some CAD systems incorrectly assume the hole in an aperture <i>clears</i> the underlying objects. This is wrong; the hole has no effect on the underlying image. <i>See 4.4.6.</i>
Objects unexpectedly appear or disappear under holes in macro apertures.	Some systems incorrectly assume that exposure off in a macro aperture <i>clears</i> the underlying objects under the flash. This is wrong, exposure off creates a hole in the aperture and that hole has no effect on the image. <i>See 4.5.2.</i>
Polygons are smaller than expected.	Some CAD systems incorrectly assume the parameter of a Regular Polygon specifies the inside diameter. This is wrong: it specifies the outside diameter. <i>See 4.4.5.</i>

Full circles unexpectedly appear or disappear.	The file contains arcs but no G74 or G75 commands. This is invalid because quadrant mode is undefined by default. A G74 or G75 command is <i>mandatory</i> if arcs are used. <i>See 2.5 and 4.10.7.</i>
The result of the MI command is not as expected.	The MI command mirrors coordinate data but not apertures. A number of implementations unfortunately also mirror apertures making MI unsafe to use. It is therefore deprecated. Do not use the MI command but apply the transformation directly in the coordinate data. <i>See 7.1.7.</i>
The result of the SF command is not as expected.	The SF command scales coordinate data but no other sizes in the file. A number of implementations unfortunately also scale other elements making SF unsafe to use. It is therefore deprecated. Do not use the SF command but apply the transformation directly in the coordinate data. <i>See 7.1.9</i>
A single Gerber file contains more than one image, separated by M00, M01 or M02	This is invalid. A Gerber file can contain only one image. One file, one image. One image, one file.
Standard Gerber or RS-274-D	Standard Gerber is revoked. It is therefore <i>no longer valid</i> Gerber. It was designed for a workflow that is as obsolete as the mechanical typewriter. It requires manual labor to process. It is not suitable for today's image exchange. See 7.10. Always use Gerber X!
Sending a PCB layer as several positive/negative files that must be merged together.	This is <i>invalid</i> in Gerber X. See 2.1. (It was valid in Standard Gerber but became obsolete with the introduction of LPD/LPC in Gerber X.) Apart from being invalid this obnoxious practice requires manual work and is error prone. One wonders why someone in his right mind would use this archaic method, which has a serious risk of scrap. One file = one layer
Strange error message.	Some files contain the strange pseudo command %ICAS*%. One wonders what this is supposed to achieve. Anyhow, it is invalid.
Error message; not the intended image.	Invalid format specification %FSD...*% The only valid zero omission options in the %FS are L and T. D is invalid. See 7.3.1.

Strange error message.	*Presence of %FSLAN2X26Y26*% The N2 in the format specification is invalid. See 4.1 One wonders what it is supposed to do.
Strange error message.	...X5555Y5555IJ001 .. Missing zero after the "I". The number after I must have at least one digit, see 4.10.

Reported errors

6.2 Bad Practices

Some Gerber files are syntactically correct but are needlessly cumbersome or error-prone. The table below summarizes common poor practices and gives the corresponding good practice.

Bad Practice	Problems	Good Practice
PCB fabrication data sets without netlist.	PCB fabrication data is complex geometric data with an infinite number of variations. Differences in the interpretation of image data is very rare but does happen and then is costly. A netlist is a powerful check on the image data – it is akin to the redundancy checks used in all data transfer protocols. Omitting a netlist is omitting a basic security check.	Always include a netlist in a PCB fabrication data set. A netlist can be provided in IPC-D-356A file or with Gerber attributes – see 5.8.4.
Writing files with deprecated constructs.	Each construct was deprecated for a reason. Many carry the risk of a misinterpretation. Continuing to use deprecated constructs is bad corporate citizenship as it blocks the industry from taking the next steps.	Generated files with current constructs only. (Note: it is OK for readers to handle deprecated constructs to cater for legacy files.)
Low resolution (numerical precision)	Poor registration of objects between PCB layers; loss of accuracy; self-intersecting contours; invalid arcs; small arcs turning in full circles, missing clearances. Poor numerical accuracy is the main cause for errors in geometric software. Low resolution is the root cause for most problems with Gerber files and sometimes leads to scrap. Why would one use low resolution? To save a few bytes? It is sometimes argued that there are Gerber readers can only handle low resolutions. This may have been true in a distant past, but we doubt it is true now. Ask yourself, will you risk scrap to cater for a few bad implementations?	Use 6 decimals in inch units and 5 or 6 decimals in mm units. See 4.1 and 7.3.
Cutting a single plane in several sections through the clearances to avoid regions with holes.	The information what the plane is and where the clearances are is lost. The reader must attempt to reverse engineer that information but may be thwarted by rounding errors. Risk of scrap. See section 4.12.5.	Construct planes with clearances using dark polarity for the plane and clear polarity for the clearances (anti-pads).

Imprecisely positioned arc center points	An imprecisely positioned center makes the arc ambiguous and open to interpretation. This can lead to unexpected results. See 4.10.1	Always position arc center points precisely.
Painted copper pours (aka stroking or vector-fill)	Painted copper pours produce the correct image but the file size explodes and getting rid of the painting require time consuming and error-prone manual work by CAM operators. Painting was needed for vector photoplotters in the 1960s and 1970s, devices now as outdated as the mechanical typewriter. There is not a single reason left to use painting.	Always define copper pours with contours (G36/G37)
Painted pads (aka stroking or vector-fill)	See painted copper pours above. Painting is even more damaging for pads. as the fabricator needs to know where the pads are. The only practical way to identify them is to use flashes for pads exclusively.	Always use flashed pads. Define pads, including SMD pads, with the AD and AM commands.
Pads as contours instead of flashes	See above.	Always use flashed pads. Define pads, including SMD pads, with the AD and AM commands.
Non-standard file extensions	When you use a non-standard file extension the reader must open the file to know what format it is and which application to use. See 3.2.	Please use “.gbr” or “.GBR” as file extension for all your Gerber files.

Poor/good practices

7 Deprecated Format Elements

7.1 Deprecated Commands

7.1.1 Overview

Current Gerber writers must not use the deprecated commands. Gerber readers may implement them to support legacy applications and files. The next table lists deprecated commands.

Code	Function	Comments
G54	Select aperture	This historic code optionally precedes an aperture selection D-code. It has no effect. Sometimes used.
G55	Prepare for flash	This historic code optionally precedes D03 code. It has no effect. Very rarely used nowadays.
G70	Set the 'Unit' to inch	These historic codes perform a function handled by the MO command. See 4.2. Sometimes used.
G71	Set the 'Unit' to mm	
G90	Set the 'Coordinate format' to 'Absolute notation'	These historic codes perform a function handled by the FS command. See 4.1. Very rarely used nowadays.
G91	Set the 'Coordinate format' to 'Incremental notation'	
M00	Program stop	This historic code has the same effect as M02. See 4.14. Very rarely used nowadays.
M01	Optional stop	This historic code has no effect. Very rarely used nowadays.
IP	Sets the 'Image polarity' graphics state parameter	IP can only be used once, at the beginning of the file. Sometimes used, and then usually as %IPPOS*% to confirm the default – a positive image; it then has no effect. <i>As it is not clear how %IPNEG*% must be handled it is probably a waste of time to try to fully implement it, and sufficient to give a warning if an image is negative.</i>
AS	Sets the 'Axes correspondence' graphics state parameter	These commands can only be used once, at the beginning of the file. The order of execution is always MI, SF, OF, IR and AS, independent of their order of appearance in the file.
IR	Sets 'Image rotation' graphics state parameter	

MI	Sets 'Image mirroring' graphics state parameter	Rarely used nowadays. If used it is almost always to confirm the default value; they have no effect. <i>It is probably a waste of time to fully implement these commands; simply ignoring them will handle the overwhelming majority of Gerber files correctly; issuing a warning when used with a non-default value protects the reader in the very rare cases this occurs.</i>
OF	Sets 'Image offset' graphics state parameter	
SF	Sets 'Scale factor' graphics state parameter	
IN	Sets the name of the file image. Has no effect. It is comment.	These commands can only be used once, at the beginning of the file. Use G04 for comments. See 4.14. Sometimes used.
LN	Loads a name. Has no effect. It is a comment.	Can be used many times in the file. Use G04 for comments. See 4.14. Sometimes used.

Deprecated Gerber Commands

The table below contains deprecated graphics state parameters.

Graphics state parameter	Values range	Fixed	Value at the beginning of a file
Axes correspondence	AXBY, AYBX See AS command	Yes	AXBY
Image mirroring	See MI command	Yes	A0B0
Image offset	See OF command	Yes	A0B0
Image polarity	POS, NEG See IP command	Yes	Positive
Image rotation	0°, 90°, 180°, 270° See IR command	Yes	0°
Scale factor	See SF command	Yes	A1B1

Deprecated graphics state parameters

7.1.2 Axis Select (AS)

The AS command is deprecated since revision I1 from December 2012.

The historic AS command sets the correspondence between the X, Y data axes and the A, B output device axes. It does not affect the image in computer to computer data exchange. It only has an effect how the image is positioned on an output device.

The AS command can only be used once, at the beginning of the file.

7.1.2.1 AS Command

The syntax for the AS command is:

<AS command> = AS(AXBY|AYBX)*

Syntax	Comments
AS	AS for Axis Select
AXBY	Assign output device axis A to data axis X, output device axis B to data axis Y. This is the default.
AYBX	Assign output device axis A to data axis Y, output device axis B to data axis X.

7.1.2.2 Examples

Syntax	Comments
%ASAXBY*%	Assign output device axis A to data axis X and output device axis B to data axis Y
%ASAYBX*%	Assign output device axis A to data axis Y and output device axis B to data axis X

7.1.3 Image Name (IN)

The IN command is deprecated since revision I1 from December 2012.

The historic IN command gives a name to the image contained in the Gerber file. The name must comply with the syntax rules for a string as described in section 3.6.6. This command can only be used once, at the beginning of the file.

IN has *no* effect on the image. A reader can ignore this command.

The informal information provide by IN can also be put a G04 comment.

7.1.3.1 IN Command

The syntax for the IN command is:

<IN command> = IN<Name>*

Syntax	Comments
IN	IN for Image Name
<Name>	Image name

7.1.3.2 Examples

Syntax	Comments
%INPANEL_1*%	Image name is 'PANEL_1'

7.1.4 Image Polarity (IP)

The IP command is deprecated since revision I1 from December 2012.

IP sets positive or negative polarity for the entire image. It can only be used once, at the beginning of the file.

7.1.4.1 Positive Image Polarity

Under *positive* image polarity, the image is generated as specified elsewhere in this document. (In other words, the image generation has been assuming positive image polarity.)

7.1.4.2 Negative Image Polarity

The purpose of negative image polarity is to create a negative image, clear areas in a dark background. The entire image plane in the background is initially dark instead of clear. The effect of dark and clear polarity is toggled. The entire image is simply reversed, dark becomes white and vice versa.

In negative image polarity, the first graphics object encountered *must* have dark polarity.

7.1.4.3 IP Command

The syntax for the IP command is:

<IP command> = IP(POS|NEG)*

Syntax	Comments
IP	IP for Image Polarity
POS	Image has positive polarity
NEG	Image has negative polarity

7.1.4.4 Examples

Syntax	Comments
%IPPOS*%	Image has positive polarity
%IPNEG*%	Image has negative polarity

7.1.5 Image Rotation (IR)

The IR command is deprecated since revision I1 from December 2012.

IR rotates the entire image counterclockwise in increments of 90° around the image origin (0, 0). All image objects are rotated.

The IR command affects the entire image. It must be used only once, at the beginning of the file.

7.1.5.1 IR Command

The syntax for the IR command is:

<IR command> = IR(0|90|180|270)*

Syntax	Comments
IR	IR for Image Rotation
0	Image rotation is 0° counterclockwise (no rotation)
90	Image rotation is 90° counterclockwise
180	Image rotation is 180° counterclockwise
270	Image rotation is 270° counterclockwise

7.1.5.2 Examples

Syntax	Comments
%IR0*%	No rotation
%IR90*%	Image rotation is 90° counterclockwise
%IR270*%	Image rotation is 270° counterclockwise

7.1.6 Load Name (LN)

The LN command is deprecated since revision 2013.10

This historic command has *no* effect on the image and can be ignored.

LN assigns a name to the subsequent part of the file. It was intended as a human-readable comment. Use the normal G04 command for human-readable comment.

The LN command can be used multiple times in a file.

7.1.6.1 LN Command

The syntax for the LN command is:

<LN command> = LN<Name>*

Syntax	Comments
LN	LN for Load Name
<Name>	The name must comply with the syntax for a string, see section 3.6.6.

7.1.6.2 Examples

Syntax	Comments
%LNVia_anti-pads*%	The name 'Via_anti-pads' is to the subsequent file section

7.1.7 Mirror Image (MI)

The MI command is deprecated since revision I1 from December 2012.

MI sets the mirroring for the coordinate data. All the *coordinate data* – and *only* coordinate data - are mirrored according to the specified factor. **Step and repeat distances are not coordinate data – see 4.11 - and hence are *not* mirrored. Apertures are *not* mirrored.**

This command affects the entire image. It can only be used once, at the beginning of the file. The default is no mirroring.



Quite a number of implementations incorrectly also mirror apertures and/or step and repeat distances. These incorrect implementations make the MI too risky to use. We strongly recommend *not* to use MI on output as you do know how the reader will interpret the file. If an image must be mirrored, write out the mirrored coordinates and apertures.

7.1.7.1 MI Command

The syntax for the MI command is:

<MI command> = MI[A(0|1)][B(0|1)]*

Syntax	Comments
MI	MI for Mirror image
A(0 1)	Controls mirroring of the A-axis data: A0 – disables mirroring A1 – enables mirroring (the image will be flipped over the B-axis) If the A part is missing, then mirroring is disabled for the A-axis data
B(0 1)	Controls mirroring of the B-axis data: B0 – disables mirroring B1 – enables mirroring (the image will be flipped over the A-axis) If the B part is missing, then mirroring is disabled for the B-axis data

7.1.7.2 Examples

Syntax	Comments
%MIA0B0*%	No mirroring of A- or B-axis data
%MIA0B1*%	No mirroring of A-axis data

	Mirror B-axis data
%MIB1*%	No mirroring of A-axis data Mirror B-axis data

7.1.8 Offset (OF)

The OF command is deprecated since revision I1 from December 2012.

OF moves the final image up to plus or minus 99999.99999 units from the imaging device (0, 0) point. The image can be moved along the imaging device A or B axis, or both. The offset values used by OF command are absolute. If the A or B part is missing, the corresponding offset is 0. The offset values are expressed in units specified by MO command.

This command affects the entire image. It can only be used once, at the beginning of the file.

7.1.8.1 OF Command

The syntax for the OF command is:

<OF command> = OF[A<Offset>][B<Offset>]*

Syntax	Comments
OF	OF for Offset
A<Offset>	Defines the offset along the output device A axis
B<Offset>	Defines the offset along the output device B axis

The **<Offset>** value is a decimal number n preceded by the optional sign ('+' or '-') with the following limitation:

$$0 \leq n \leq 99999.99999$$

The decimal part of n consists of not more than 5 digits.

7.1.8.2 Examples

Syntax	Comments
%OFA0B0*%	No offset
%OFA1.0B-1.5*%	Defines the offset: 1 unit along the A axis, -1.5 units along the B axis
%OFB5.0*%	Defines the offset: 0 units (i.e. no offset) along the A axis, 5 units along the B axis

7.1.9 Scale Factor (SF)

The SF command is deprecated since revision I1 from December 2012..

SF sets a scale factor for the A- and/or B-axis coordinate data. All the *coordinate data* – and *only* coordinate data - are multiplied by the specified factor for the corresponding axis. **Step and repeat distances – see 4.11 - are not coordinate data and hence are not scaled. Apertures are not scaled.**

This command affects the entire image. It can only be used once, at the beginning of the file. The default scale factor is '1'. The factor values must be between 0.0001 and 999.99999. The scale factor can be different for A and B axes.



Quite a number of implementation incorrectly also scale step and repeat distances. These incorrect implementations make the SF too risky to use. We strongly recommend *not* to use SF on output as you do know how the reader will interpret the file. If an image must be scaled, write out the scaled coordinates.

7.1.9.1 SF Command

The syntax for the SF command is:

<SF command> = SF[A<Factor>][B<Factor>]*

Syntax	Comments
SF	SF for Scale Factor
A<Factor>	Defines the scale factor for the A-axis data
B<Factor>	Defines the scale factor for the B-axis data

The **<Factor>** value is an unsigned decimal number n with the following limitation:

$$0.0001 \leq n \leq 999.99999$$

The decimal part of n consists of not more than 5 digits.

7.1.9.2 Examples

Syntax	Comments
%SFA1B1*%	Scale factor 1
%SFA.5B3*%	Defines the scale factor: 0.5 for the A-axis data, 3 for the B-axis data

7.2 Coordinate Data without Operation Code

Coordinate data *without explicit operation code* after a D01, on other words the modal use of D01, is deprecated since revision I1 from December 2012.

A D01 code sets the deprecated operation mode to interpolate. It remains in interpolate mode till any other D code is encountered. In sequences of D01 operations this allows omitting an explicit D01 code after the first operation.



Example:

```
D10*  
X700Y1000D01*  
X1200Y1000*  
X1200Y1300*  
D11*  
X1700Y2000D01*  
X2200Y2000*  
X2200Y2300*
```

The operation mode is *only* defined after a D01. The operation mode after a D02, D03 or an aperture selection (Dnn with $nn \geq 10$) is *undefined*. Therefore a file containing coordinates without operation code after a D03 or an aperture selection (Dnn with $nn \geq 10$) is invalid.



Warning: Coordinate data without explicit operation code saves a few bytes but its exact use is not intuitive in relation to D03. The risk of scrap far outweighs the meager benefit.

7.3 Format Specification Options

This section describes deprecated options of the FS command (see 4.1).

The FS command could also be used to specify the following format characteristics:

- Trailing zero omission
- Incremental coordinate notation
- Low resolution (less than 6 decimals in inch units and less than 5 in mm units).

7.3.1 Trailing Zero Omission

Trailing zero omission is deprecated since revision 2015.06.

Trailing zero omission some or all trailing zero's can be omitted but all leading zero's are required. To interpret the coordinate string, it is first padded with zero's at the back until its length fits the coordinate format. For example, with the "23" coordinate format, "15" is padded to "15000" and therefore represents 15.000.

The coordinate data must contain at least one digit. Zero therefore should be encoded as "0".

Trailing zero omission is specified by 'T' after the FS code. (The normal leading zero omission is specified by 'L' after the FS code.)



Example:

```
%FSTAX25Y25*%
```

Trailing zero omission is rarely found in legacy files. Gerber readers will go a long way without supporting it.

7.3.2 Incremental Notation

Incremental notation is deprecated since revision I1 from December 2012.

Incremental notation means that coordinate values are as the incremental distances from the previous coordinate position. It is specified by the "I" in the FS command, after the "L" or "T" for leading or trailing. (The normal absolute notation is specified by 'A' in the FS command.)



Example:

```
%FSLIX25Y25*%
```

```
%FSTIX36Y36*%
```

Incremental notation was sometimes used as a simplistic compression when saving a few bytes was a fantastic advantage, and before the invention of Lempel–Ziv–Welch (LZW) and other *lossless* compression methods. The problem is that the accumulation of rounding errors leads to significant loss of precision. This results in poor registration, invalid arcs, self-intersecting contours, often resulting in scrap. Avoid incremental notation like the plague.

Incremental notation is fortunately but rarely used in legacy files. Gerber readers will go a long way without supporting it.

7.3.3 Low resolution

Low resolution, this is using less than 6 decimals in inch units and less than 5 decimals in mm units is deprecated since revision 2015.06.

Low resolution was introduced in the 1960's as a simplistic compression method when saving a few bytes was of paramount importance, and computers were too feeble for proper *lossless* compression methods such as Lempel–Ziv–Welch (LZW).

Alas, low resolution loses numerical precision and it is well known that poor numerical precision is the main cause of often obscure bugs in geometric software. It is not different in Gerber software. It leads to poor registration of objects between PCB layers; loss of accuracy; self-intersecting contours; invalid arcs; small arcs turning in full circles, missing clearances.

Unfortunately, low resolution files are quite common. There are even files in inch with 3 decimals, or a resolution of 1 mil; this is asking for problems. Low resolution is the main cause of problems with Gerber files, sometimes leading to scrap. It is sometimes recommended to use low resolution because many Gerber readers allegedly only handle low resolutions. Do not listen. This may - just may - have been true in a distant past, but no longer, if ever. Ask yourself: does it make sense to risk scrap to save a few bytes or to cater for a few rumored stone-age implementations? The days that saving a few bytes was important are long gone. The risks of low resolution remain. Avoid low resolution like the plague.

Low resolution files are unfortunately quite common in legacy files. Gerber readers will fail to handle a significant fraction of Gerber files if they do not support low resolutions.

7.4 Using G01/G02/G03 in a data block with D01/D02

This construction is deprecated since revision 2015.06.

The function codes G01, G02, G03 could be put together with operation codes in the same data block. The graphics state is then modified before the operation coded is executed, whatever the order of the codes.



Example:

```
G01X100Y100D01*  
X200Y200D01*
```

G01 sets the interpolation mode to linear and this used to process the coordinate data X100Y100 from the same data block as well as the coordinate data X200Y200 from the next data block. This construction is a useless variation and now it is deprecated. However, it happens quite frequently in legacy files, so readers may want to support it.

The syntax for G01, G02, G03 codes in operations with codes D01 and D02 was the following:

<Operation> = G(1|01|2|02|3|03)<Coordinate data>D(01|02)*



Example:

```
G01*  
X100Y100D01*  
G01X500Y500D01*  
X300Y300D01*  
G01X100Y100D01*
```

7.5 Deprecated usage of SR

These constructions are deprecated since revision 2016.01.

The command `%SRX1Y1I0J0*%` strictly speaking starts a step and repeat of 1x1, i.e. no step and repeat at all. It is historically sometimes used as an alternative for an `%SR*%` to close an SR statement. This is still used quite frequently.

Sometimes an SR command other than 1x1 such as `%SRX2Y3I1,5J2.2*%` is put seemingly inside an SR statement. Its effect is then to terminate the current SR statement and start a new one with its parameters. This is used rarely.

The Backus-Naur form for such a deprecated SR statement is:

<single command> = all commands except SR, AB, G36, G37 and M02

<region statement> See 4.12

<SR open> = %SRX<Repeats>Y<Repeats>I<Step>J<Step>*%

<SR close> = (%SR*%|%SRX1Y1I0J0*%)

<SR body> = <SR open>{<single command>|<region statement>}

<SR statement> = <SR body>{<SR body>}<SR close>

Another deprecated variation is that an SR statement at the end of a file is not closed. The end of file `M02*` is then an implicit close. This is used rarely.

Another variation is that the file header contains a `%SRX1Y1I0J0*%`. This does not mean a futile 1x1 step and repeat is started. It just indicates that the file does not start with a step and repeat, which is obvious. This command can be ignored. This is used quite frequently.

7.6 Rectangular Hole in Standard Apertures

Rectangular holes in standard apertures are deprecated since revision 2015.06.



In addition to the round hole described in section 4.4 older versions of this specification also allowed rectangular holes. Rectangular holes do not rotate with the aperture, according to these historic specifications. This is very counterintuitive and a source of errors. Because of this problem and because rectangular holes are not very useful they were deprecated. Do not use them. If you need a rectangular hole construct a macro aperture.

The syntax of a rectangular hole is common for all standard apertures:

<Hole> = <X-axis hole size>X<Y-axis hole size>

The modifiers specify the X and Y sizes of the hole. Decimals >0.

The hole must strictly fit within the standard aperture. It is centered on the aperture.



Example:

```
%FSLAX26Y26*%
%MOIN*%
%ADD10C,10X5X5*%
%ADD11C,1*%
G01*
%LPD*%
D11*
```

X-10000000Y-2500000D02*
X10000000Y2500000D01*
D10*
X0Y0D03*
M02*

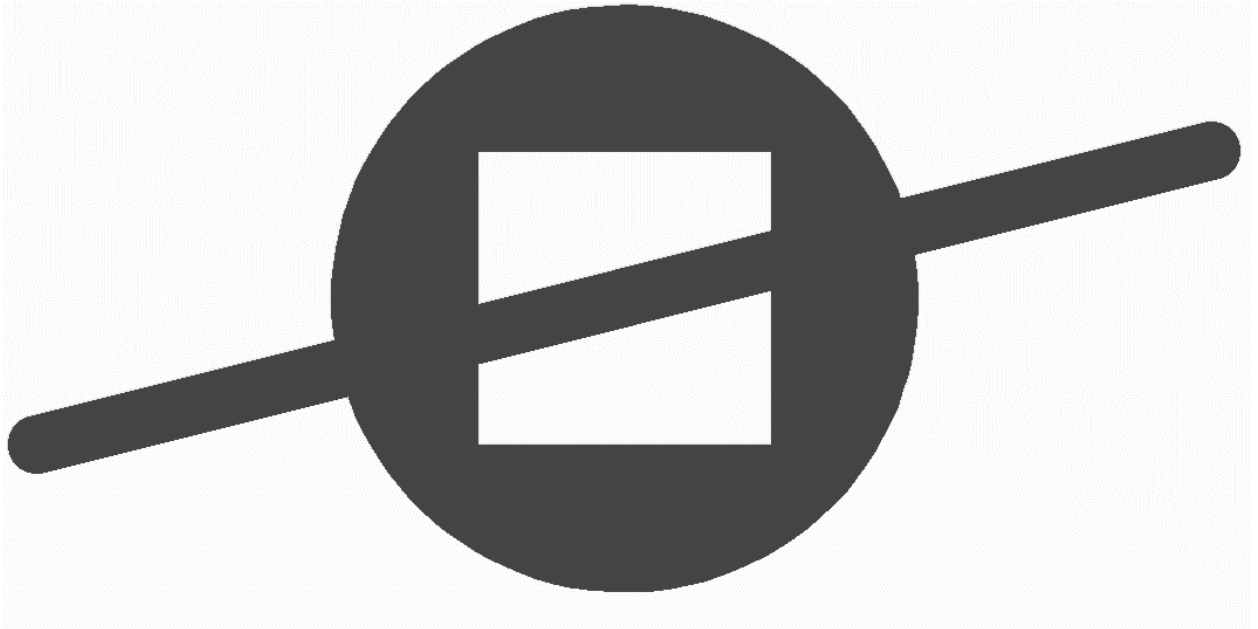

54. Standard (circle) aperture with a rectangular hole above a draw

Note that the draw is visible through the hole.

Rectangular holes appear very rarely in legacy files.

7.7 Painting or Vector-fill

In the 1960's and 1970s, the era of vector plotters, when the region statement was not available, the only way to define a copper pour was by painting it with a large number of overlapping draws. This produces the correct image but the file size explodes and, more importantly, such painted data cannot be handled properly in PCB CAM; the painted data must laboriously be converted to proper regions.

Painted areas and pads are not suited for PCB fabrication. Sending files with painted to a PCB fabricator is quite disrespectful.

7.8 Deprecated Terminology

- ❑ *Mass parameters* was the original term for extended commands. Mass parameters made sense at the moment of its introduction but became awkward over time.
- ❑ *Polygon fill* was used for contour fill.
- ❑ *Coordinate date block* was used of operation.
- ❑ The following synonyms for “darken” could be used: mark, expose, paint
- ❑ The following synonyms for “clear” could be used: unmark, rub, erase, scratch
- ❑ The term “stroking” is used as the synonym of “painting”
- ❑ Incremental position: position expressed as a distance in X and Y from the current point

7.9 Deprecated Attribute Values

The following values for the .AperFuntion attribute were deprecated in 2019.06

CutOut	PCB cut-outs. This is the generic term for a hole other than a drill hole.
Slot	PCB slots. This is a subset of the cut-outs. Which cut-outs are called slots is subjective. In case of doubt use the value CutOut.
Cavity	Cavities in a PCB.

7.10 Standard Gerber (RS-274-D)

The current Gerber file format is also known as RS-274X or Extended Gerber. There is also a historic format called Standard Gerber or RS-274-D format.

Standard Gerber is technically obsolete. It and was revoked in revision I1 from December 2012 and superseded by RS-274X.

Standard Gerber is revoked and superseded by Extended Gerber, which is the current Gerber format. Consequently, Standard Gerber no longer complies with the Gerber specification. Files in that format can no longer be correctly called Gerber files. Standard Gerber files are not only deprecated, they are no longer valid.



It differs from the current Gerber file format (RS-274X), in that it:

- does not support G36 and G37 codes
- does not support any extended comands

Standard Gerber does not allow defining the coordinate format and aperture shapes. It is incomplete as an image description format. It lacks the imaging primitives needed to unequivocally transfer information from PCB CAD to CAM.

The word “standard” is misleading here. Standard Gerber is standard NC format. It is not a standard image format: image generation needs a so-called wheel file, and that wheel file is not governed by a standard. The interpretation of a wheel files, and consequently of a Standard Gerber files, is subjective. In Extended Gerber (RS-274X) image generation is fully governed by the standard. Extended Gerber is the true image standard.

Standard Gerber has major drawbacks compared to the current Gerber file format and does not offer a single advantage. Standard Gerber is obsolete. There is not a single valid reason to use standard Gerber rather than Extended Gerber.

Always use Extended Gerber (RS-274X). Never use Standard Gerber.

 **Warning:** The responsibility of errors or misunderstandings about the wheel file when processing a Standard Gerber file rests solely with the party that decided to use revoked Standard Gerber, with its informal and non-standardized wheel file, rather than Extended Gerber, which is unequivocally and formally standardized.

8 References

*American National Standard for Information Systems — Coded Character Sets — 7-Bit
American National Standard Code for Information Interchange (7-Bit ASCII), ANSI X3.4-1986*

<https://en.wikipedia.org/wiki/MD5>

<https://en.wikipedia.org/wiki/Unicode>

http://en.wikipedia.org/wiki/ISO_8601

https://en.wikipedia.org/wiki/Binary_image

[https://en.wikipedia.org/wiki/Zip_\(file_format\)](https://en.wikipedia.org/wiki/Zip_(file_format))

<http://www.rfc-base.org/txt/rfc-4122.txt>

[https://msdn.microsoft.com/en-us/library/windows/desktop/aa378623\(v=vs.85\).aspx](https://msdn.microsoft.com/en-us/library/windows/desktop/aa378623(v=vs.85).aspx)

https://developer.apple.com/library/mac/documentation/Foundation/Reference/NSUserDefaults_Class/

9 History

The Gerber file format derives its name from the former Gerber Systems Corp. A leading supplier of vector photoplotters from the 1960s onwards, Gerber based its plotter input on a subset of the EIA RS-274-D NC format, and in 1980, it published a well-written specification titled “Gerber Format: a subset of EIA RS-274-D; plot data format reference book”. The format was so well suited for its task that it was widely adopted and became the de-facto standard format for vector plotters, known as *Standard Gerber*.

Vector photoplotters are NC machines, and Standard Gerber, which is dedicated to vector photoplotters, is an NC format. As of the 1980s, vector photoplotters started losing ground to raster plotters. Based on bitmap technology, these newer devices demanded rather more than a simple NC format, so Gerber extended the original NC format with so called “Mass Parameters”, converting it to a fully-fledged image file formats. This resulted in a family of effective image description formats designed specifically to drive Gerber’s PCB devices and raster plotters. In 1998 Gerber Systems Corp. was taken over by Barco and incorporated into its PCB division – Barco ETS, now Ucamco. At this point, Barco drew all the variants in Gerber’s family of formats into a single standard image format.

On September 21, 1998 Barco-Gerber published the Gerber RS-274X Format User’s Guide. The format became known as Extended Gerber or GerberX. This is a full image description format, which means that an Extended Gerber file contains the complete description of a PCB layer, providing everything needed for an operator to generate a PCB image, and enabling any aperture shape to be defined. Unlike Standard Gerber, it does not need the support of additional external files, and it specifies planes and pads clearly and simply without the need for painting or vector-fill. The Extended Gerber format quickly superseded Standard Gerber as the de facto standard for PCB image data, and is sometimes called “the backbone of the electronics industry”. A sequence of revisions clarifying the specification was published over the years, culminating in revision H of January 2012.

During 2012, Ucamco reviewed the entire format in depth in “the great reform”. Over 10.000 files from all over the world were gathered into a representative library to help establish current practice. Rarely used and historic format elements were deprecated. Format elements with conflicting interpretations in the market were either deprecated or clarified. The specification document itself was re-organized, the quality of the text and the drawings improved and many new drawings were added. This resulted in The Gerber Format Specification, revision I1 published in December 2012. Revisions I2, I3 and finally I4 from November 2013 further improved the document. The result was a powerfully clear and simple format, without needless embellishments, focused on the current needs of the PCB industry. This version of the Gerber Format was developed by Karel Tavernier and Rik Breemeersch. They were assisted by an advisory group including Ludek Brukner, Artem Kostyukovich, Jiri Martinek, Adam Newington, Denis Morin, Karel Langhout and Dirk Leroy. Grateful thanks are extended to all those who helped the development of the revision by posting their questions, remarks and suggestions on the Ucamco website. Particular thanks are due to Paul Wells-Edwards whose insightful comments contributed substantially to the revision.

Until this point, Gerber was purely an image description format. Recognizing that a PCB image must be supported with meta-information that describes, say, the function of an image file in the layer structure, Ucamco realized that it could convey that information clearly and unequivocally using attributes. Accordingly, and in June 2013, the company publicly proposed to extend the Gerber format using attributes, and invited feedback on its proposal from the Gerber user community. The outcome of this was revision J1, completed in February 2014, during which Gerber got its attributes. It was a major step forward for the format, at least on a par with the changes made when Standard Gerber became Extended Gerber. Sometimes called the second extension, the latest version of the Gerber format is known as Gerber version 2, or X2 (as

opposed to X1, which is Gerber without attributes). Gerber version 2 is fully backward compatible as attributes do not affect the image at all. Subsequent revisions, J2 to J4, clarified the specification and added new standard attributes. Gerber version 2 was developed by Karel Tavernier, Ludek Brukner and Thomas Weyn. They were assisted by an advisory group including Roland Polliger, Luc Samyn, Wim De Greve, Dirk Leroy and Rik Breemeersch.

In September 2014 Ucamco published an open letter declaring Standard Gerber obsolete and revoking it.

In August 2015, Ucamco published a draft specification *adding nested step and repeat* and block apertures to make panel descriptions more efficient, calling for comments from the user community. In November 2016 the review process was closed after substantial input and modifications and the final version included in revision 2016.12. This revision was developed by Karel Tavernier and Rik Breemeersch.

Early in 2015, the entire specification was reviewed once again by Karel Tavernier, Thomas Weyn and Artem Kostyukovich focused on making the specification easier to read and understand, while taking great care to ensure consistent and precise terminology. Some further elements were identified as superfluous and were deprecated. Not least, special attention was given to the 'Overview' chapter, with the aim of turning it into a tutorial that can be understood by non-experts. The result of this work is revision 2015.06.

In July 2016 Karel Tavernier from Ucamco published a draft specification to include netlist information in Gerber for public review. Several revisions of the draft were triggered by input from users. The final version was included in revision 2016.11 from November 2, 2016.

In March 2017 Karel Tavernier from Ucamco published a draft specification to include fab documentation in Gerber for public review.

10 Revisions

10.1 Revision 2019.06

The .AperFunction values CutOut, Slot and Cavity were deprecated. See 7.9.

Made it more explicit that macro aperture names cannot be reused, see 4.5.1. Corrected an error in the examples in 4.12.4.2, pointed out by Abe Tusk, and in 2.1, pointed out by Radim Halíř.

10.2 Revision 2018.11

Removed the .PF attribute, and replaced its content by an additional optional field to the .P attribute. See 5.6.14.

Fixed a number of typos and minor errors pointed out by Jörg Naujoks, Rik Breemeersh and Radim Halíř.

Revision 2018.11 was developed by Karel Tavernier,

10.3 Revision 2018.09

Corrected an error in the polygon aperture, section 4.4.5, and polygon primitive, section 4.5.4.7. Clarified the rotation of the deprecated rectangular holes in apertures, section 7.6 These issues were pointed out by Remco Poelstra.

Corrected an error in the moiré primitive specification, section 4.5.4.8. The error was pointed out by Vasily Turchenko.

Clarified how object attributes are attached to regions, triggered by remarks from Radim Halíř.

Defined allowed range of the scale factor in 4.11.5, as suggested by Andreas Weidinger.

Defined orientation of text mirroring in section 5.6.12. Triggered by Nicholas Meeker.

Nicholas Meeker, Andreas Weidinger, Radim Halíř and Denis Morin carefully proofread the document, which resulted in many text corrections.

Revision 2018.09 was developed by Karel Tavernier.

10.4 Revision 2018.06

Removed PressFit option from the ComponentPad attribute value; it is also a ComponentDrill option and that is sufficient.

Clarified pad attribute values for via, component, SMD, BGA on inner layers. Clarified FS command, see 4.1 and 7.3. Fixed broken links to references indicated by Vasily Turchenko.

Revision 2018.06 was developed by Karel Tavernier.

10.5 Revision 2018.05

Added .PF attribute, as suggested by Matthew Sanders.

Corrected errors in an example in 4.11.1 pointed out by Erik Forwerk. Corrected errors in the SR definition and Backus-Naur form pointed out by Remco Poelstra, see 4.13. Simplified the

Backus-Naur form of the region statement, see 4.12.2. Corrected an error in 5.4 pointed out by Dries Soentjens.

Revision 2018.05 was developed by Karel Tavernier.

10.6 Revision 2017.11

Allow the .N attribute not only on copper layers but also on plated drill layers, see 5.6.13.

Remove .FileFunction value Keep-out. Use Profile instead.

Specified that to combine files zip is the only allowed archive format, as suggested by Rafal Powierski.

Simplified the Backus-Naur form of aperture blocks, see 4.6.2. Added synoptic table with macro primitives in 4.5.4.1. Added synoptic table one with standard apertures in 4.4.1. Added Backus-Naur form of the region statement. Added link to the Reference Gerber Viewer in 1.3. Fixed typos pointed out by Forest Darling. Fixed a number of typos pointed out by Radim Halíř.

Revision 2017.11 was developed by Karel Tavernier.

10.7 Revision 2017.05

Added the new file attribute .SameCoordinates, see 5.6.5.

Added file functions Depthrout, Viafill, Vcut, and Vcutmap.

Created section 5.7 with guidelines on the use of attributes in fabrication data; added guidelines on how to define the PCB profile in 5.8.2.

Reorganized and edited the chapter Overview. Clarified section on zero-size apertures. Corrected an error in the comment in example 2.13.3 pointed out by Nav Mohammed. Corrected errors in the examples in 5.6.5 pointed out by Rik Breemeersch,

Revision 2017.05 was developed by Karel Tavernier.

10.8 Revision 2017.03

Added section 5.7, specifying how to put text in the image.

We now allow upper case 'X' as well as the multiply operator on macro's, next to the lower case 'x'. This conforms to wide-spread practice. This was triggered by a question from Oliver Broad.

Changed file function *Glumask* to *Glue*; added explanation; see 5.6.3.

Reorganized chapter 4. Extended section 4.12.5.

Corrections in 4.11.1, 4.11.5, 4.12.1 and in Aperture Attributes on Regions triggered by remarks from Remco Poelstra. Corrected an error in example 2.13.2 pointed out by Danilo Bargaen.

Revision 2017.03 was developed by Karel Tavernier.

10.9 Revision 2016.12

This is a major revision with powerful new imaging functions: 4.6, 0, 4.11.4 and 4.11.5. These allow nested step and repeat to define panels efficiently, see 4.6.3 and 4.6.4.

There are fixes for errors in examples, pointed out by Danilo Bargaen and Urban Bruhin.

Revision 2016.12, and especially the new imaging function for panels was developed by Karel Tavernier and Rik Breemeersch. The first draft of these functions was published in August 2016. During the public review process. Thomas Weyn, Bruce McKibben, Masao Miyashita and Remco Poelstra provided essential input.

10.10 Revision 2016.11

This major revision allows to include the CAD netlist to Gerber files by adding three new standard object attributes – see 5.7 above. The goal of the Gerber CAD netlist is to facilitate upfront communication between the different parties involved in design, assembly and automation. The X2 attributes proposed include CAD netlists in Gerber fabrication data and allow to:

- Attach the component reference designator, pin number and net name to the component pads in the outer copper layers. This information is essential for a complete board display and for a complete board display. More importantly, the netlist provides a powerful checksum to guarantee PCB fabrication data integrity.
- Attach the netlist name to any conducting object on any copper layer. Lightweight viewers can then display netlists without the need for an algorithm to compute connectivity
- Attach the component reference to any object, e.g. to identify all the legend objects belonging to a given component, for example.

Several text improvements. Section 4.12.3 on regions clarified triggered by deep questions asked by Remco Poelstra.

Revision 2016.11 was developed by Karel Tavernier. Jean-Pierre Charras provided essential input on the CAD netlist, and further remarks by Remco Poelstra and Wim De Greve were included.

10.11 Revision 2016.09

New or modified attribute values – see 5.6.10:

- Replaced file function *Drawing* with *OtherDrawing*.
- Added the optional field *Filled|NotFilled* to *ViaDrill*.
- Added aperture function *EtchedComponent*.

Added object attributes – see 5.4. Object attributes attach information to individual graphics objects.

Corrected an error in example 4.12.4.7. The error was pointed out by Thomas van Soest and Siegfried Hildebrand. Clarified the syntax of attaching aperture attributes to regions. Added Perl script to show precisely how to calculate the .MD5. Several other clarifications.

Revision 2016.09 was developed by Karel Tavernier.

10.12 Revision 2016.06

Added a section on back-drilling job triggered by questions from Alexey Sabunin. See 5.8.2.1.

The .ProjectID UUID was changed to RFC4122; rewritten by Remco Poelstra. See 5.6.8.

Aperture function attributes were clarified triggered by remarks from John Cheesman. Drill sizes were clarified triggered by remarks from Jeff Loyer.

10.13 Revision 2016.04

Added PressFit label to component drill and pad attributes; see ComponentPa and ComponentDrill. Revoked default on current point.

Text improvements that do not change the format: Removed superfluous concept of level and replaced the name 'Level Polarity' by 'Load Polarity'. Various other text improvements.

10.14 Revision 2016.01

Added drill and pad functions for castellated holes. Added optional types break-out and tooling on MechanicalDrill.

Deprecated closing an SR with the M02.

Text improvements that do not change the format: Clarified .AperFunction attribute values. Clarified when to use of standard or user attributes. Clarified how aperture attributes can be set on regions.

10.15 Revision 2015.10

Added items to section Errors and Bad Practices.

Added file function attribute .FilePolarity.

Refined drawing .FileFunction attributes Replaced Mechanical by FabricationDrawing and Assembly by AssemblyDrawing. Added definitions to the drawing types. Added mandatory (Top|Bot) to .AssemblyDrawing, as suggested by Malcolm Lear. Added ArrayDrawing.

10.16 Revision 2015.07

The superfluous and rarely, if ever, used macro primitives 2 and 22 were revoked. The .AperFunction aperture attribute was simplified:

- Filled / NotFilled option is removed for the ViaDrill function
- ImpC / NotC option is removed from the Conductor function

10.17 Revision 2015.06

The entire document was revised for clarity. The readability of the text was improved. The terminology was made consistent. The glossary was expanded. A number of additional images were added, including the Gerber file processing diagrams, command types diagram, aperture macro rotation illustration. Some of existing images were recreated to improve the quality. Several new tables were added to explain the relation between D code commands and graphics state parameters. The glossary was updated. The sections were rearranged. Several new sections (0, 4.12.3, 4.7, 7.2, 7.3) and subsections (4.9, 4.10, 4.12, 5) were added.

The use of G codes in a data block together with D codes was deprecated. The rectangular hole in standard apertures was deprecated. Usage of low resolutions and trailing zero omission in the FS command was deprecated

The number after D/G/M letter in function code commands now can contain more leading zeros. The mistakenly omitted rotation parameter of the circle macro primitive was restored. Unicode escape sequences in strings are now possible.

New file attributes were specified: `.GenerationSoftware` (5.6.5), `.CreationDate` (5.6.5) and `.ProjectId` (5.6.8).

As of now the revision numbering follows the year.month scheme as in 2015.06.

10.18 Revision J4 (2015 02)

The `.AperFunction` values “Slot”, “CutOut” and “Cavity” were added. The text on standard attributes was made more explicit. An example of a poorly constructed plane was added.

10.19 Revision J3 (2014 10)

The `.FileFunction` values for copper and drill layers were extended to contain more information about the complete job.

10.20 Revision J2 (2014 07)

Attaching aperture attributes with regions was much simplified. A section about numerical accuracy was added.

10.21 Revision J1 (2014 02)

This revision created Gerber X2 by adding attributes to what was hitherto a pure image format. See chapter 5. X2 is Gerber version 2, with “X1” being Gerber version 1, without attributes. Gerber X2 is backward compatible as attributes do not affect image generation.

10.22 Revision I4 (2013 10)

The commands LN, IN and IP were deprecated. The possibility of re-assigning D codes was revoked.

The regions overview section 4.12.1 was expanded and examples were added different places in 4.12 to further clarify regions. The chapters on function codes and syntax were restructured. The constraints on the thermal primitive parameters were made more explicit. Wording was improved in several places. The term ‘(mass) parameter’ was replaced by ‘extended command’.

10.23 Revision I3 (2013 06)

Questions about the order and precise effect of the deprecated commands MI, SF, OF, IR and AS were clarified. Coincident contour segments were explicitly defined.

10.24 Revision I2 (2013 04)

The “exposure on/off” modifier in macro apertures and the holes in standard apertures are sometimes incorrectly implemented. These features were explained in more detail. Readers and writers of Gerber files are urged to review their implementation in this light.

10.25 Revision I1 (2012 12)

General. The entire specification was extensively reviewed for clarity. The document was re-organized, the quality of the text and the drawings has been improved and many new drawings were added.

Deprecated elements. Elements of the format that are rarely used and superfluous or prone to misunderstanding have been deprecated. They are grouped together in the second part of this document. The first part contains the current format, which is clean and focused. *We urge all creators of Gerber files no longer to use deprecated elements of the format.*

Graphics state and operation codes. The underlying concept of the *graphics state* and operation codes is now explicitly described. See section 2.5 and 2.5. *We urge all providers of Gerber software to review their implementation in the light of these sections.*

Defaults. In previous revisions the definitions of the default values for the modes were scattered throughout the text, or were sometimes omitted. All default values are now unequivocally specified in an easy-to-read table. See 2.5. *We urge all providers of Gerber software to review their handling of defaults.*

Rotation of macro primitives. The rotation center of macro primitives was clarified. See 4.5.3. *We urge providers of Gerber software to review their handling of the rotation of macro primitives.*

G36/G37. The whole section is now much more specific. *We urge providers of Gerber software to review their contour generation in this light.*

Coordinate data. Coordinate data without D01/D02/D03 in the same data block can lead to confusion. It therefore has been deprecated. See 7.2. *We urge all providers of Gerber software to review their output of coordinate data in this light.*

Maximum aperture number (D-code). In previous revisions the maximum aperture number was 999. This was insufficient for current needs and numerous files in the market use higher aperture numbers. We have therefore increased the limit to the largest number that fits in a signed 32-bit integer.

Standard Gerber. Standard Gerber is revoked because it has many disadvantages and not a single advantage. *We urge all users of Gerber software not to use Standard Gerber any longer.*

Incremental coordinates. These have been deprecated. Incremental coordinates lead to rounding errors. *Do not use incremental coordinates.*

Name change: area and contour instead of polygon. Previous revisions contained an object called a polygon. As well as creating confusion between this object and a polygon aperture, the term is also a misnomer as the object can also contain arcs. These objects remain unchanged but are now called areas, defined by their contours. This does not alter the Gerber files.

Name change: level instead of layer. Previous revisions of the specification contained a concept called a layer. These were often confused with PCB layers and have been renamed as levels. This is purely narrative and does not alter the Gerber files.